

GATEMATE[®]
SUPERIOR GATE FURNITURE

SUPERIOR GATE FURNITURE

PRODUCT CATALOGUE



FENCEMATE[®]
SUPERIOR FENCING ACCESSORIES

SITEMATE[®]
SUPERIOR TOOLS AND FIXINGS

patura

**LITTLE
MONKEY**[®]
DESIGN · BUILD · PLAY

GATEMATE®

SUPERIOR GATE FURNITURE

...giving you the ability to fit your **doors, gates and fences**, with everything at your fingertips!

Discover one of the largest ranges of pre-packed door and gate furniture, supplied complete with all the screws and fixings you'll need.

- ✓ **Ideal for all your needs...** from simple bolts and hinges to complete gate kits, specialist fixings and ornamental ironmongery; there's genuinely something for every job!
- ✓ **Straightforward and convenient...** pre-packed complete with the right type and number of fixings, Gatemate door and gate furniture is easy to understand and easy to use.
- ✓ **Quality, reliability and durability, guaranteed...** the best materials, the best designs, the best manufacturing: we may offer competitive prices, but we don't compromise on quality.

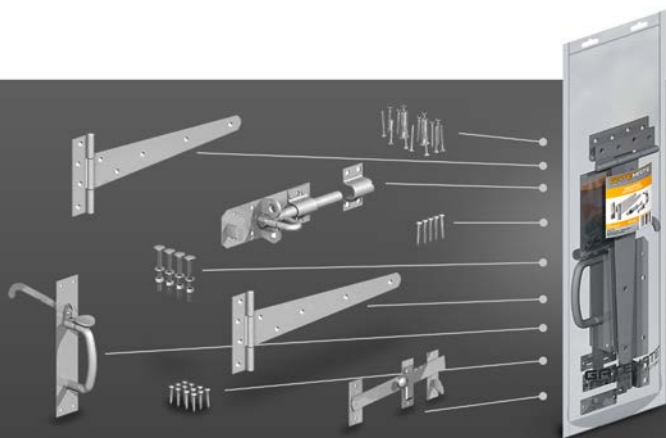

**EVERYTHING
YOU NEED
IN ONE PACK!**



HANDLES, LOCKS
AND SECURITY
P5



HAND RAIL AND
SHELF BRACKETS
P12



FIELD GATE
FITTINGS
P12



GATE FIXING KITS
P19



HINGES
P20



LATCHES,
CATCHES AND
BOLTS
P26



GATE SIGNS AND
REFLECTORS
P34



LOCKING BARS
AND HASP &
STAPLES
P34



STAINLESS STEEL
P36



PREMIUM BLACK
P38



ORNAMENTAL
P39



HIGH PERFORMANCE
COMPOSITE
HARDWARE
P44



FENCING
ACCESSORIES
P48



CHAIN, WIRE AND
ROPE FITTINGS
P50



TRAILER FITTINGS
P53



METAL GATES
AND AUTOMATION
ACCESSORIES
P55

Finishes



Galvanised

A 'hot-dip' or 'spelter' galvanised finish approximately 60 microns thick. The product is dipped in molten zinc, resulting in a thick, rough coating that has high corrosion resistance.

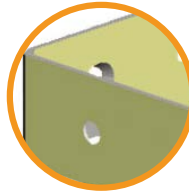

Zinc Plated/YP

These products have a zinc plated finish with an additional yellow passivating treatment. This extra layer increases the corrosion resistance and gives the product a light yellow appearance.



Zinc Plated

These products have been finished with a process of electroplating zinc onto steel, resulting in a shiny finish about 6-8 microns thick. Although Zinc plated products are typically cheaper than Galvanised ones, they usually rust more easily due to the thinner coating.

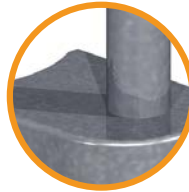

Self Colour

Unfinished steel. These products are typically used in fabrication, and will naturally rust very quickly – this should be removed prior to galvanisation.



Pre-Galvanised

These products are fabricated from sheet steel that has already been galvanised, giving a finish approximately 20 microns thick. The resulting corrosion resistance is between that of hot-dip galvanising and zinc plating.



Premium Black

A hot-dip galvanised finish with a black polyester powder coating on top. This double layer results in a high level of corrosion resistance and attractive, smooth appearance.



Epoxy Black/ Epoxy Brown

Polyester powder coating is baked or sprayed onto the raw metal, resulting in a smooth finish. Medium corrosion resistance, however on moving parts the finish can flake off, meaning the steel will corrode more easily.



Stainless Steel

Stainless steel is an iron alloy with a high level of chromium, giving it an external layer that is virtually rust free. Our premium stainless steel products are made from grade 316 stainless steel, which is a marine grade stainless steel for ultimate corrosion resistance! Ideal for coastal and other high-moisture areas.



Ruspert

Ruspert is a rustproof treatment technology with superior corrosion resistance. An organic coating containing aluminium flakes and special rustproof paint passivates the metallic layer chemically, prevents intrusion of corrosive factors from outside and controls the self-sacrificial galvanic effect of zinc. Our high performance screws, decking screws and hex head timber screws all have a ruspert finish for ultimate performance and longevity.



Pewter

Zinc coating is applied, followed by a pewter finish and a clear lacquer to achieve this beautiful finish. Pewter finish highlights the texture of the steel attractively, however pewter products will need regular wiping with an oily cloth to keep them in good condition.



Handles, Locks and Security

GATEMATE EURO PROFILE LONG THROW LOCK

DESCRIPTION	SIZE mm	FINISH	QTY/BOX	CODE
Double Locking Premium Rimlock (A)	2 (50)	Black/ Stainless Steel	1	149 0086
Double Locking Premium Rimlock (A)	2½ (70)	Black/ Stainless Steel	1	149 0096
Single Locking Premium Rimlock with Thumb Turn (B)	2 (50)	Black/ Stainless Steel	1	149 0106
Single Locking Premium Rimlock with Thumb Turn (B)	2½ (70)	Black/ Stainless Steel	1	149 0116
Euro Profile Key Blank Only		Chrome		149 000C

PATENT PENDING.



NEW

GATEMATE EURO PROFILE LONG THROW LOCK - KEYED ALIKE

DESCRIPTION	SIZE mm	FINISH	QTY/BOX	CODE
Double Locking Premium Rimlock (A)	2 (50)	Black/ Stainless Steel	1	149 0126
Double Locking Premium Rimlock (A)	2½ (70)	Black/ Stainless Steel	1	149 0136
Single Locking Premium Rimlock with Thumb Turn (B)	2 (50)	Black/ Stainless Steel	1	149 0146
Single Locking Premium Rimlock with Thumb Turn (B)	2½ (70)	Black/ Stainless Steel	1	149 0156

PATENT PENDING.

Size = Gate/door depth.

High corrosion resistance; grade 316 stainless steel shoot bol.

Elongated anti-rattle keep (patent pending) to prevent rattling during windy weather.

Chrome escutcheon plate.

High security Euro profile 6 pin lock barrel.

Drill bits and stainless steel security screws included.

Unique bolt design with hardened core to prevent cutting.

All locks supplied with 5 keys.

See matching Gatemate pull handles on following page.

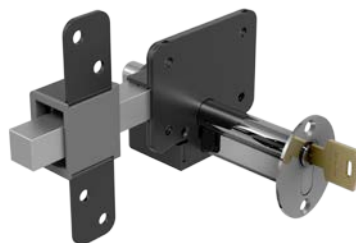
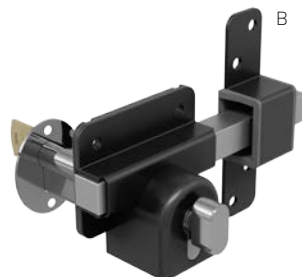

USE WITH GATEMATE SECURITY ESCUTCHEON (BELOW) FOR ULTIMATE SECURITY

Handles, Locks and Security

NEW

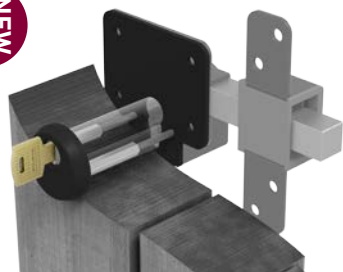

GATEMATE SECURITY ESCUTCHEON FOR EURO PROFILE LONG THROW LOCK

Ensure the security of your Gatemate Euro Profile Long Throw Lock by installing this high security escutcheon.

FINISH	QTY/BOX	CODE
Epoxy black	1	149 003C

- High intruder resistance.
- All fixings and fitting instructions included.
- Anti-cut, anti-tamper and anti-drill.
- Clean, in-line design.
- Highly corrosion resistant gloss black finish.

NEW



GATEMATE PULL HANDLE FOR EURO PROFILE LOCK

SIZE ins (mm)	FINISH	QTY/BOX	CODE
8 (200)	Epoxy Black	5	147 2013
8 (200)	Chrome	5	147 201C

Includes all fixings.

GATEMATE PREMIUM LONG THROW LOCK

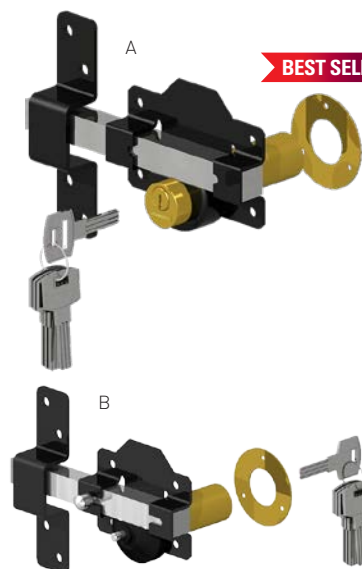

DESCRIPTION	SIZE mm	FINISH	QTY/BOX	CODE
Double Locking Premium Rimlock (A)	2 (50)	Black/ Stainless Steel	1	149 0186
Double Locking Premium Rimlock (A)	2¾ (70)	Black/ Stainless Steel	1	149 0196
Single Locking Premium Rimlock with Thumb Turn (B)	2 (50)	Black/ Stainless Steel	1	149 1106
Single Locking Premium Rimlock with Thumb Turn (B)	2¾ (70)	Black/ Stainless Steel	1	149 1116
Key Blank Only		Chrome	1	149 0000



Now Sold Secure Bronze when used with the Gatemate Security Escutcheon.



GATEMATE PREMIUM LONG THROW LOCK - KEYED ALIKE

DESCRIPTION	SIZE mm	FINISH	QTY/BOX	CODE
Double Locking Premium Rimlock (A)	2 (50)	Black/ Stainless Steel	1	149 1126
Double Locking Premium Rimlock (A)	2¾ (70)	Black/ Stainless Steel	1	149 1136
Single Locking Premium Rimlock with Thumb Turn (B)	2 (50)	Black/ Stainless Steel	1	149 1146
Single Locking Premium Rimlock with Thumb Turn (B)	2¾ (70)	Black/ Stainless Steel	1	149 1156

Size = Gate/door depth.

6 pin lock barrel.

Grade 316 stainless steel shoot and back plate.

All locks supplied with 5 keys.

See matching Gatemate pull handles on opposite page.

Includes all fixings.

Sold Secure Bronze when used with the Gatemate security escutcheon (below).

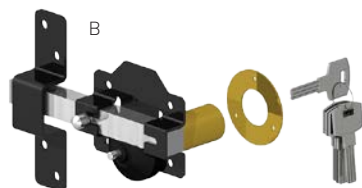
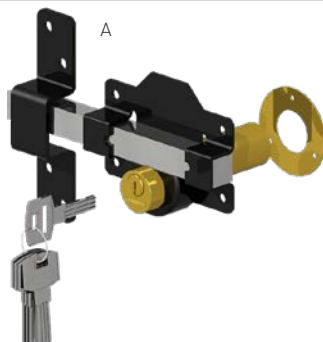

GATEMATE SECURITY ESCUTCHEON FOR LONG THROW LOCK

The Gatemate long throw lock is now Sold Secure when used with our new Security Escutcheon. Super easy to fit, the escutcheon encloses the exposed part of the lock barrel and bolts securely through the gate to a back plate that sits neatly behind the lock plate.

FINISH	QTY/BOX	CODE
Epoxy black	1	149 0006

Sold Secure Bronze Certified.

High intruder resistance.

All fixings and fitting instructions included.

Anti-cut, anti-tamper and anti-drill .

Clean, in-line design.

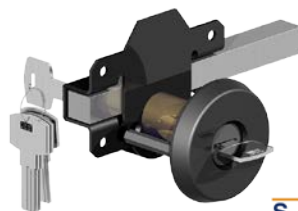

NEW



GATEMATE PREMIUM LONG THROW LOCK PULL HANDLE

SIZE ins (mm)	FINISH	QTY/BOX	CODE
8 (200)	Epoxy Black	5	147 2003
8 (200)	Brass	5	147 2005
8 (200)	Chrome	5	147 200C

Includes all fixings.



SPADE DRILL FOR LONG THROW LOCKS

SIZE mm	QTY/BOX	CODE
28	1	SP0 0280



Handles, Locks and Security



GATEMATE PRESSED STEEL HANDLE

SIZE ins (mm)	FINISH	QTY/BOX	CODE
7 (175)	Zinc Plated	5	547 1752
7 (175)	Epoxy Black	5	547 1753

Includes fixings.



GATEMATE DOOR-GATE HANDLE

SIZE ins (mm)	FINISH	QTY/BOX	CODE
6 (150)	Galvanised	5	537 1501
6 (150)	Epoxy Black	5	537 1503

Includes fixings.



GATEMATE RIMSASHLOCK AND FURNITURE

DESCRIPTION	SIZE ins (mm)	FINISH	QTY/BOX	CODE
Rimsashlock	6x4 (150x100)	Epoxy Black	5	540 0010
Rimsashlock furniture	2 (50)	Black Plastic	5	540 0020

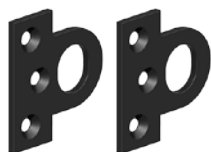

GATEMATE PADLOCK EYES

SIZE ins (mm)	FINISH	QTY/BOX	CODE
2 (50)	Black on stainless steel	5	149 0513

Includes fixings.

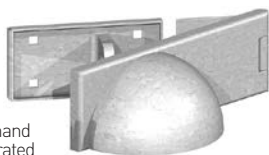

Left hand illustrated

GATEMATE PADLOCK PROTECTOR

DESCRIPTION	FINISH	QTY/BOX	CODE
Left hand	Galvanised	1	144 1851
Right hand	Galvanised	1	144 1861

Includes fixings.



GATEMATE SHED SECURITY BAR

SIZE mm	FINISH	QTY/BOX	CODE
1000	Galvanised	1	139 1001
1800	Galvanised	1	139 1801

Includes fixings.

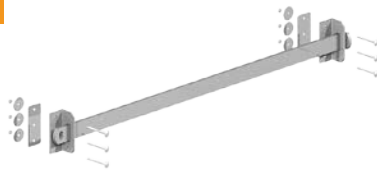

GATEMATE PRIKKA STRIP (PACK OF 1M)

The effective, low cost deterrent against unwelcome intruders. Prikka Strip is a triple row of pointed cones, moulded from polypropylene with excellent UV weathering resistance. Can be fitted to tops of fences, gates, pipes, walls and sills etc.

SIZE mm	FINISH	QTY/BOX	CODE
500x45	Grey	5	848 5008
500x45	Brown	5	848 5003

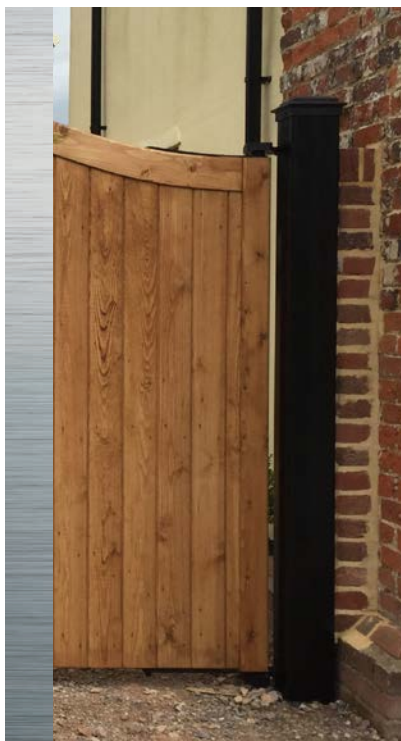
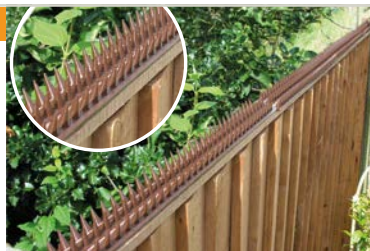

NEW!
ADJUSTABLE
STEEL GATE
POST SYSTEM
 DESIGNED
 FOR GATE
 AUTOMATION
 SYSTEMS

See page 55



Handles, Locks and Security

NEW



GATEMATE BRASS PADLOCK

SIZE mm	SHACKLE	FINISH	QTY/BOX	CODE
30	Standard	Brass	5	148 0300
40	Standard	Brass	5	148 0400
50	Standard	Brass	5	148 0500
60	Standard	Brass	5	148 0600
70	Standard	Brass	5	148 0700
40	Long	Brass	5	148 0410
50	Long	Brass	5	148 0510

With hardened shackle.

NEW



GATEMATE BRASS PADLOCK - KEYED ALIKE (2 PACK)

SIZE mm	FINISH	QTY/BOX	CODE
40	Brass	5	148 2400
50	Brass	5	148 2500

With hardened shackle.

NEW



GATEMATE BRASS PADLOCK - KEYED ALIKE (4 PACK)

SIZE mm	FINISH	QTY/BOX	CODE
40	Brass	5	148 4400
50	Brass	5	148 4500

With hardened shackle.

NEW



GATEMATE LAMINATED STEEL PADLOCK

SIZE mm	SHACKLE	FINISH	QTY/BOX	CODE
30	Standard	Laminated Steel	5	713 0300
40	Standard	Laminated Steel	5	713 0400
50	Standard	Laminated Steel	5	713 0500
60	Standard	Laminated Steel	5	713 0600
40	Long	Laminated Steel	5	713 0410
50	Long	Laminated Steel	5	713 0510

With hardened shackle.



GATEMATE LAMINATED STEEL PADLOCK - KEYED ALIKE (2 PACK)

SIZE mm	FINISH	QTY/BOX	CODE
40	Laminated Steel	5	713 2400
50	Laminated Steel	5	713 2500

With hardened shackle.



NEW

GATEMATE LAMINATED STEEL PADLOCK - KEYED ALIKE (4 PACK)

SIZE mm	FINISH	QTY/BOX	CODE
40	Laminated Steel	5	713 4400
50	Laminated Steel	5	713 4500

With hardened shackle.



NEW

GATEMATE HEAVY DUTY ARMoured BLOCK PADLOCK

SIZE mm	FINISH	QTY/BOX	CODE
60	Steel/Nickle plated	5	708 0600
70	Steel/Nickle plated	5	708 0700
80	Steel/Nickle plated	5	708 0800
90	Steel/Nickle plated	5	708 0900



NEW

GATEMATE HEAVY DUTY ARMoured BLOCK PADLOCK - KEYED ALIKE (2 PACK)

SIZE mm	FINISH	QTY/BOX	CODE
70	Steel/Nickle plated	5	708 2700
80	Steel/Nickle plated	5	708 2800

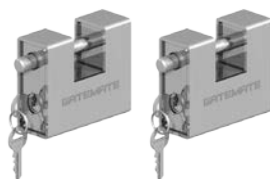

NEW

GATEMATE STAINLESS STEEL DISCUS PADLOCK

SIZE mm	FINISH	QTY/BOX	CODE
60	Stainless Steel	5	771 0600
70	Stainless Steel	5	771 0700
80	Stainless Steel	5	771 0800
90	Stainless Steel	5	771 0900



NEW

GATEMATE STAINLESS STEEL DISCUS PADLOCK - KEYED ALIKE (2 PACK)

SIZE mm	FINISH	QTY/BOX	CODE
70	Stainless Steel	5	771 2700
80	Stainless Steel	5	771 2800



NEW

Handrails and Shelf Brackets



GATEMATE HANDRAIL BRACKETS (PACK OF 2)

SIZE ins (mm)	FINISH	QTY/BOX	CODE
2½ (65)	Zinc Plated	5	833 0652
2½ (65)	White	5	833 0657
2½ (65)	Epoxy Black	5	833 0653
3 (75)	Zinc Plated	5	833 0752
3 (75)	White	5	833 0757
3 (75)	Epoxy Black	5	833 0753

Size = Handrail distance from wall.
Includes fixings.



NEW

GATEMATE FOLDING SHELF BRACKET

LENGTH mm	FINISH	QTY/BOX	CODE
8x5 (200x125)	Chrome	5	585 200C
14x5 (350x125)	Chrome	5	585 350C

Easy to use folding multi-purpose bracket. Ideal for confined spaces.

Field Gate Fittings

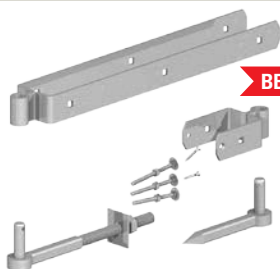

GATEMATE STANDARD DOUBLE STRAP HINGE SET

SIZE ins (mm)	FINISH	QTY/BOX	CODE
24 (600)	Galvanised	4	030 6001
18 (450)	Galvanised	4	030 4501
12 (300)	Galvanised	4	030 3001
24 (600)	Epoxy Black	4	030 6003
18 (450)	Epoxy Black	4	030 4503
12 (300)	Epoxy Black	4	030 3003

For 3" gates. Includes: 2"x¼" top band, **5"x2"x¼"** bottom band, **13"** hook to bolt, hook to drive and fixings.

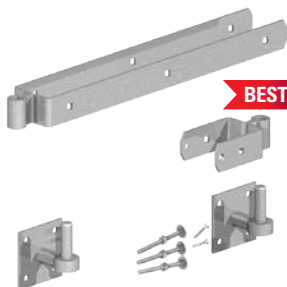

GATEMATE DOUBLE STRAP HINGE SET WITH HOOKS ON PLATES

SIZE ins (mm)	FINISH	QTY/BOX	CODE
24 (600)	Galvanised	4	031 6001
18 (450)	Galvanised	4	031 4501
12 (300)	Galvanised	4	031 3001

For 3" gates. Includes: 2"x¼" top band, **5"x2"x¼"** bottom band, **2** hooks on **4"** plates and fixings.



GATEMATE DOUBLE STRAP HINGE SET WITH 11" HOOK TO BOLT

SIZE ins (mm)	FINISH	QTY/BOX	CODE
24 (600)	Galvanised	4	030 6011
24 (600)	Epoxy Black	4	030 6013

For 3" gates. Includes: 2"x1/4" top band, 5"x2"x1/4" bottom band, 11" hook to bolt, hook to drive and fixings.

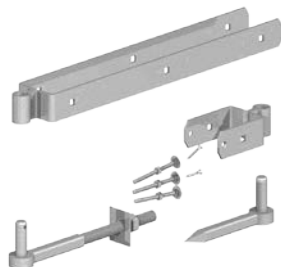

GATEMATE DOUBLE STRAP HINGE SET WITH GATE HANGER TO BOLT

SIZE ins (mm)	FINISH	QTY/BOX	CODE
24 (600)	Galvanised	4	030 6021

For 3" gates. Includes: 2"x1/4" top band, 5"x2"x1/4" bottom band, 14" gate hanger to bolt, hook to drive and fixings.

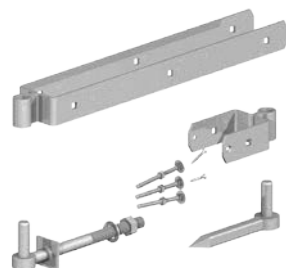

GATEMATE ADJUSTABLE HINGE SET

SIZE ins (mm)	FINISH	QTY/BOX	CODE
24 (600)	Galvanised	4	032 6001
18 (450)	Galvanised	4	032 4501
12 (300)	Galvanised	4	032 3001
24 (600)	Epoxy Black	4	032 6003
18 (450)	Epoxy Black	4	032 4503
12 (300)	Epoxy Black	4	032 3003

For 3" gates. Includes: 2"x1/4" top band, adjustable gate eye and heel clips, hook to bolt, hook to drive and fixings.

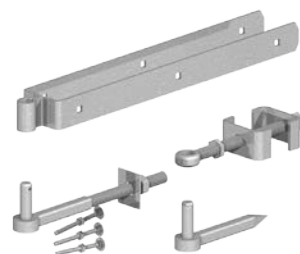

GATEMATE ADJUSTABLE HINGE SET WITH HOOKS ON PLATES

SIZE ins (mm)	FINISH	QTY/BOX	CODE
24 (600)	Galvanised	4	033 6001
18 (450)	Galvanised	4	033 4501
12 (300)	Galvanised	4	033 3001
24 (600)	Epoxy Black	4	033 6003

For 3" gates. Includes: 2"x1/4" top band, adjustable gate eye and heel clips, 2 hooks on 4" square plates and fixings.

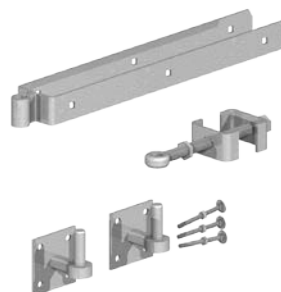

Field Gate Fittings

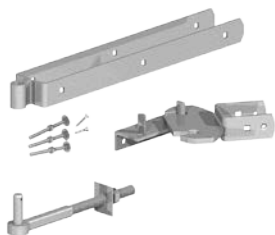

GATEMATE RISING HINGE SET WITH ROCKER PLATE

SIZE ins (mm)	FINISH	QTY/BOX	CODE
24 (600)	Galvanised	4	034 6001

For 3" gates. Includes: 24"x2"x1/4" top band, hook to bolt, bottom band, rocker plate and fixings. Approximate rise 75mm per metre width of gate, when gate is open at 90° to post (gate to be hung between the posts).

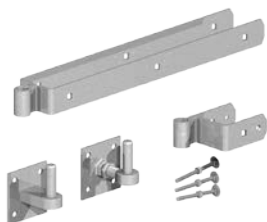

GATEMATE SELF CLOSING/RISING 45° HINGE SET

SIZE ins (mm)	FINISH	QTY/BOX	CODE
18 (450)	Galvanised	4	034 4511

For 3" gates. Includes: 18" top band with 1" diameter eye, 5" bottom band with offset eye on corner, hook on 4" plate, adjustable hook on 4" plate with 3/4" diameter hook and fixings (gate to be hung between the posts).

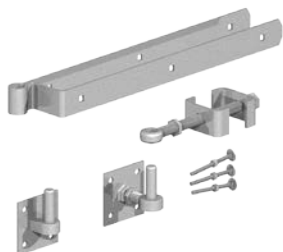

GATEMATE SELF CLOSING/RISING 90° HINGE SET

SIZE ins (mm)	FINISH	QTY/BOX	CODE
24 (600)	Galvanised	4	034 6011

For 3" gates. Includes: 24" top band with 1" straight eye on corner, adjustable gate eye and heel clips, 3/4" gate hook on 4" plate, adjustable hook on 4" plate with 3/4" diameter eye and fixings (gate to be hung on rear of posts).

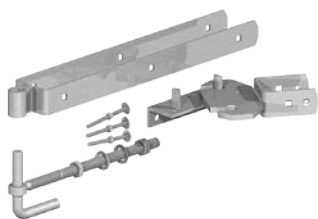

GATEMATE SELF CLOSING 2 WAY 180° HINGE SET

SIZE ins (mm)	FINISH	QTY/BOX	CODE
24 (600)	Galvanised	2	034 6021

For 3" gates. Includes: 24" top band with 1" diameter eye, bottom band, rocker plate, 15" lock through hook with 3/4" diameter pin and fixings (gate to be hung between posts).

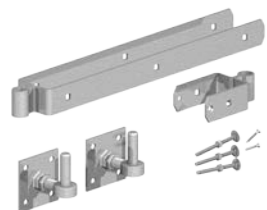

GATEMATE DOUBLE STRAP HINGE SET WITH ADJUSTABLE HOOK ON PLATE

SIZE ins (mm)	FINISH	QTY/BOX	CODE
24 (600)	Galvanised	4	030 6521
18 (450)	Galvanised	4	030 4521

For 3" gates. Includes: 2"x1/4" top band, 5"x2"x1/4" bottom band, 2 adjustable hooks on 4" square plates with 3/4" diameter eye and fixings.



GATEMATE DOUBLE STRAP HINGE SET WITH SLOTTED BOTTOM BAND

SIZE ins (mm)	FINISH	QTY/BOX	CODE
24 (600)	Galvanised	4	035 6001

For 3" gates. Includes: 2"x1/4" top band, 5"x2"x1/4" slotted bottom band, hook to bolt, hook to drive and fixings.

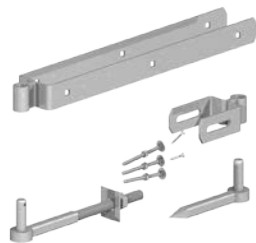

GATEMATE SAFETY GATE HOOK AND EYE

SIZE ins (mm)	FINISH	QTY/BOX	CODE
6 (150)	Galvanised	5	528 1501

Includes chain and eyes.



GATEMATE NORTHUMBERLAND GATE FASTENER

SIZE ins (mm)	FINISH	QTY/BOX	CODE
16 (400)	Galvanised	5	571 3001
16 (400)	Epoxy Black	5	571 3003



GATEMATE NEW ZEALAND GATE FASTENER

SIZE mm	FINISH	QTY/BOX	CODE
420	Zinc Plated	5	571 4202
1000	Zinc Plated	5	571 1002



GATEMATE THROWOVER LOOP

SIZE ins (mm)	FINISH	QTY/BOX	CODE
14 (350)	Galvanised	5	560 3501

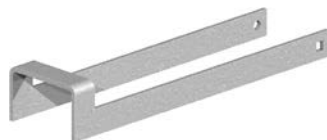

GATEMATE SPRING FASTENER SET

DESCRIPTION	SIZE ins (mm)	FINISH	QTY/BOX	CODE
With staple catch	24 (600)	Galvanised	10	036 0001
With staple catch	24 (600)	Epoxy Black	10	036 0003
With drive catch	24 (600)	Galvanised	10	037 0001
With central closing catch	24 (600)	Galvanised	10	037 0011

For 3" gates. Includes: spring fastener, catch, keep and fixings.



Field Gate Fittings

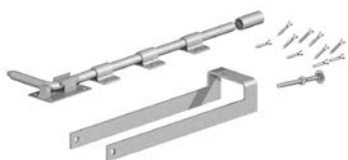

GATEMATE STANDARD DOUBLE GATE FASTENER SET

SIZE	FINISH	QTY/BOX	CODE
For 3" Gates	Galvanised	10	038 0001

Includes: 18" dropbolt, 14" throwover loop and fixings.



GATEMATE DOUBLE GATE FASTENER SET (WITH 2 BOLTS)

SIZE	FINISH	QTY/BOX	CODE
For 3" Gates	Galvanised	10	038 0021

Includes: 2 x 18" dropbolts, 14" throwover loop and fixings.

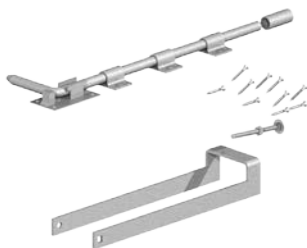

GATEMATE DOUBLE GATE FASTENER SET WITH 24" GARAGE DOOR BOLT

SIZE	FINISH	QTY/BOX	CODE
For 3" Gates	Galvanised	10	038 0011

Includes: 24" dropbolt, 14" throwover loop and fixings.

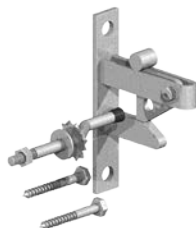

GATEMATE SELF-LOCKING GATE CATCH KIT

DESCRIPTION	PACK TYPE	FINISH	QTY/BOX	CODE
With cranked striker	Gatemate bag	Galvanised	5	563 0001
With cranked striker	Plain box	Galvanised	10	039 0001
With double leg striker	Plain box	Galvanised	10	039 0011

Includes fixings.

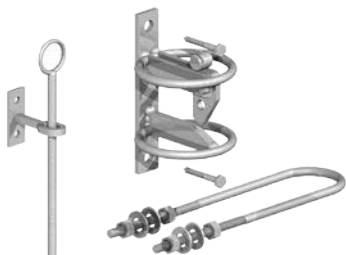

GATEMATE ANIMAL SAFETY SELF LOCKING GATE CATCH KIT

FINISH	PACK TYPE	QTY/BOX	CODE
Galvanised	Plain box	1	039 0041

Includes fixings.



GATEMATE HUNTING TYPE LIFT CATCH KIT

FINISH	PACK TYPE	QTY/BOX	CODE
Galvanised	Plain box	1	039 0031

Includes fixings.



GATEMATE HUNTING TYPE LOCKING GATE CATCH KIT

FINISH	QTY/BOX	CODE
Galvanised	1	564 0001

Includes fixings.



GATEMATE CENTRAL CLOSING CATCH

FINISH	QTY/BOX	CODE
Galvanised	5	568 0001

Includes fixings.

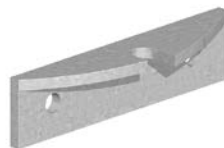

GATEMATE SHOOT BOLT

FINISH	QTY/BOX	CODE
Galvanised	5	566 0001

Includes fixings.



GATEMATE ADJUSTABLE GATE EYE (PACK OF 2)

SHANK DIA mm	SIZE ins (mm)	FINISH	QTY/BOX	CODE
12	4x½ (100x12)	Zinc Plated	5	549 4122
12	6x½ (150x12)	Zinc Plated	5	549 6122
16	4x⅝ (100x16)	Zinc Plated	5	549 4162
16	6x⅝ (150x16)	Zinc Plated	5	549 6162
20	4x¾ (100x20)	Zinc Plated	5	549 4202
20	6x¾ (150x20)	Zinc Plated	5	549 6202
20	8x¾ (200x20)	Zinc Plated	5	549 8202
25	6x1 (150x25)	Galvanised	5	549 6251
30	8x1¼ (200x30)	Galvanised	5	549 8321

Size = Thread length x Compatible pin diameter.
Includes 4 nuts per pack.



GATEMATE GATE STAPLE ROUND PATTERN (PACK OF 5)

SIZE ins (mm)	FINISH	QTY/BOX	CODE
2½ (65)	Galvanised	5	577 0651
3 (75)	Galvanised	5	577 0751
4 (100)	Galvanised	5	577 1001
6 (150)	Galvanised	5	577 1501



Field Gate Fittings



GATEMATE GATE STAPLE TO DRIVE

SIZE ins (mm)	FINISH	QTY/BOX	CODE
4 (100)	Galvanised	5	579 1001

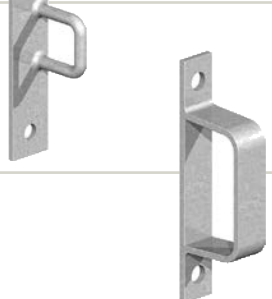

GATEMATE GATE STAPLE ON ELONGATED PLATE

SIZE ins (mm)	FINISH	QTY/BOX	CODE
3 (75)	Galvanised	5	578 0751

Includes fixings.



GATEMATE 'D' BRACKET

SIZE ins (mm)	FINISH	QTY/BOX	CODE
3½ (89)	Galvanised	5	578 0801

Includes fixings.

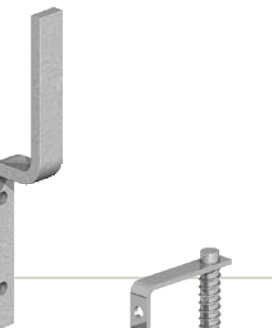

GATEMATE SLIP RAIL BRACKET

SIZE ins (mm)	FINISH	QTY/BOX	CODE
4x2 (100x50)	Galvanised	5	529 0001

Includes fixings.



GATEMATE RAIL BRACKETS (PACK OF 2)

SIZE ins (mm)	FINISH	QTY/BOX	CODE
2 (50)	Galvanised	5	583 0511

Includes fixings.

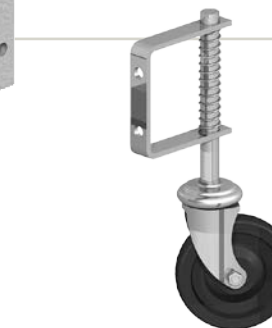

GATEMATE MEDIUM DUTY SPRING LOADED GATE WHEEL

SIZE ins (mm)	FINISH	QTY/BOX	CODE
11 (280)	Zinc Plated	5	581 2802

Includes fixings.



Gate Fixing Kits

GATEMATE PEDESTRIAN GATE KIT

FINISH	QTY/BOX	CODE
Galvanised	5	595 0001
Zinc Plated	5	595 0002
Epoxy Black	5	595 0003

Comprises of 1 pair 14" medium tee hinges, 1 x medium auto catch and fixings to suit.



GATEMATE SIDE GATE KIT WITH RING GATE LATCH

DESCRIPTION	FINISH	QTY/BOX	CODE
With 18" tee hinges	Galvanised	5	596 0001
With 18" tee hinges	Zinc Plated	5	596 0002
With 18" tee hinges	Epoxy Black	5	596 0003
With 16" tee hinges	Galvanised	5	596 0111
With 16" tee hinges	Epoxy Black	5	596 0113

Comprises of 1 pair medium tee hinges, 1 x 6" ring gate latch, 1 x 6x1/2" brenton padbolt and fixings to suit.



GATEMATE SIDE GATE KIT WITH SUFFOLK LATCH

DESCRIPTION	FINISH	QTY/BOX	CODE
With 18" tee hinges	Galvanised	5	597 0001
With 18" tee hinges	Zinc Plated	5	597 0002
With 18" tee hinges	Epoxy Black	5	597 0003
With 16" tee hinges	Galvanised	5	597 0111
With 16" tee hinges	Epoxy Black	5	597 0113

Comprises of 1 pair medium tee hinges, 1 x heavy suffolk latch, 1 x 6x1/2" brenton padbolt and fixings to suit.



GATEMATE CURVE RAIL HINGE KITS HANDED

DESCRIPTION	SIZE ins (mm)	FINISH	PAIRS/BOX	CODE
Left hand	12 (300)	Galvanised	5	598 0001
Right hand	12 (300)	Galvanised	5	598 0011

Specify left or right handed kit when ordering.
Includes fixings.



Hinges



GATEMATE LIGHT TEE HINGES

SIZE ins (mm)	FINISH	PAIRS/BOX	CODE
4 (100)	Zinc Plated	5	501 1002
6 (150)	Zinc Plated	5	501 1502
8 (200)	Zinc Plated	5	501 2002
10 (250)	Zinc Plated	5	501 2502
12 (300)	Zinc Plated	5	501 3002
4 (100)	Epoxy Black	5	501 1003
6 (150)	Epoxy Black	5	501 1503
8 (200)	Epoxy Black	5	501 2003
10 (250)	Epoxy Black	5	501 2503
12 (300)	Epoxy Black	5	501 3003

Includes fixings.

Material thickness between 1.00 and 1.50mm.



GATEMATE MEDIUM TEE HINGES

SIZE ins (mm)	FINISH	PAIRS/BOX	CODE
12 (300)	Galvanised	5	502 3001
14 (350)	Galvanised	5	502 3501
15 (375)	Galvanised	5	502 3751
16 (400)	Galvanised	5	502 4001
18 (450)	Galvanised	5	502 4501
24 (600)	Galvanised	5	502 6001
10 (250)	Zinc Plated	5	502 2502
12 (300)	Zinc Plated	5	502 3002
14 (350)	Zinc Plated	5	502 3502
15 (375)	Zinc Plated	5	502 3752
16 (400)	Zinc Plated	5	502 4002
18 (450)	Zinc Plated	5	502 4502
24 (600)	Zinc Plated	5	502 6002
10 (250)	Epoxy Black	5	502 2503
12 (300)	Epoxy Black	5	502 3003
14 (350)	Epoxy Black	5	502 3503
15 (375)	Epoxy Black	5	502 3753
16 (400)	Epoxy Black	5	502 4003
18 (450)	Epoxy Black	5	502 4503
24 (600)	Epoxy Black	5	502 6003

BEST SELLER

BEST SELLER

Includes fixings.

Material thickness between 1.80 and 2.50mm.



GATEMATE MEDIUM TEE HINGES 1.5 PAIRS

SIZE ins (mm)	FINISH	PAIRS/BOX	CODE
18 (450)	Galvanised	5	502 4511
18 (450)	Zinc Plated	5	502 4512
18 (450)	Epoxy Black	5	502 4513

Includes fixings.

Material thickness between 1.80 and 2.50mm.

One extra hinge per set gives additional strength for higher use or heavier applications.



GATEMATE STRONG TEE HINGES

SIZE ins (mm)	FINISH	PAIRS/BOX	CODE
6 (150)	Galvanised	5	503 1501
8 (200)	Galvanised	5	503 2001
10 (250)	Galvanised	5	503 2501
12 (300)	Galvanised	5	503 3001
14 (350)	Galvanised	5	503 3501
16 (400)	Galvanised	5	503 4001
18 (450)	Galvanised	5	503 4501
20 (500)	Galvanised	5	503 5001
24 (600)	Galvanised	5	503 6001
6 (150)	Zinc Plated	5	503 1502
8 (200)	Zinc Plated	5	503 2002
10 (250)	Zinc Plated	5	503 2502
12 (300)	Epoxy Black	5	503 3003
14 (350)	Epoxy Black	5	503 3503
16 (400)	Epoxy Black	5	503 4003
18 (450)	Epoxy Black	5	503 4503
24 (600)	Epoxy Black	5	503 6003

Includes fixings.

Material thickness between 2.00 and 3.50mm.



GATEMATE HEAVY TEE HINGES

SIZE ins (mm)	FINISH	PAIRS/BOX	CODE
4 (100)	Galvanised	5	516 1001
4 (100)	Zinc Plated	5	516 1002
12 (300)	Zinc Plated	5	516 3002
15 (375)	Zinc Plated	5	516 3752
18 (450)	Zinc Plated	5	516 4502

Includes fixings.

Material thickness between 2.00 and 3.00mm.

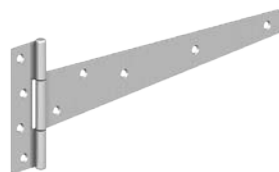

Hinges

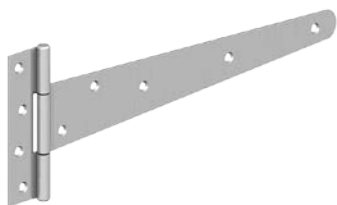

GATEMATE WEIGHTY SCOTCH TEE HINGES

SIZE ins (mm)	FINISH	PAIRS/BOX	CODE
4 (100)	Galvanised	5	505 1001
6 (150)	Galvanised	5	505 1501
8 (200)	Galvanised	5	505 2001
10 (250)	Galvanised	5	505 2501
12 (300)	Galvanised	5	505 3001
14 (350)	Galvanised	5	505 3501
16 (400)	Galvanised	5	505 4001
18 (450)	Galvanised	5	505 4501

Includes fixings.

Material thickness between 2.00 and 4.00mm.



GATEMATE MEDIUM STRAP HINGES

SIZE ins (mm)	FINISH	PAIRS/BOX	CODE
8 (200)	Zinc Plated	5	522 2002
10 (250)	Zinc Plated	5	522 2502
12 (300)	Zinc Plated	5	522 3002

Includes fixings.

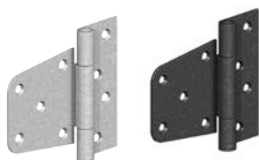

GATEMATE HEAVY DUTY OFFSET HINGES

SIZE ins (mm)	FINISH	PAIRS/BOX	CODE
3½ (89)	Galvanised	5	602 0011
3½ (89)	Zinc Plated	5	602 0012
3½ (89)	Epoxy Black	5	602 0013

Includes fixings.



FOR **ULTIMATE**
CORROSION
RESISTANCE - CHECK
OUT OUR RANGE OF
GATEMATE STAINLESS
STEEL FITTINGS See
Pages 36-37



GATEMATE STRAIGHT BANDS AND HOOKS ON PLATES

SIZE ins (mm)	FINISH	PAIRS/BOX	CODE
10 (250)	Galvanised	5	506 2501
12 (300)	Galvanised	5	506 3001
14 (350)	Galvanised	5	506 3501
16 (400)	Galvanised	5	506 4001
18 (450)	Galvanised	5	506 4501
20 (500)	Galvanised	5	506 5001
24 (600)	Galvanised	2	506 6001
30 (750)	Galvanised	2	506 7501
36 (900)	Galvanised	2	506 9001
10 (250)	Epoxy Black	5	506 2503
12 (300)	Epoxy Black	5	506 3003
14 (350)	Epoxy Black	5	506 3503
16 (400)	Epoxy Black	5	506 4003
18 (450)	Epoxy Black	5	506 4503
20 (500)	Epoxy Black	5	506 5003
24 (600)	Epoxy Black	2	506 6003
30 (750)	Epoxy Black	2	506 7503
36 (900)	Epoxy Black	2	506 9003

Includes fixings.

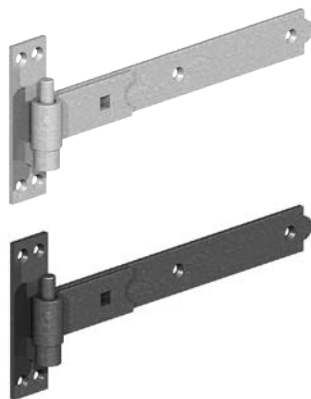

GATEMATE CRANKED BANDS AND HOOKS ON PLATES

SIZE ins (mm)	FINISH	PAIRS/BOX	CODE
10 (250)	Galvanised	5	507 2501
12 (300)	Galvanised	5	507 3001
14 (350)	Galvanised	5	507 3501
16 (400)	Galvanised	5	507 4001
18 (450)	Galvanised	5	507 4501
20 (500)	Galvanised	5	507 5001
24 (600)	Galvanised	2	507 6001
30 (750)	Galvanised	2	507 7501
36 (900)	Galvanised	2	507 9001
10 (250)	Epoxy Black	5	507 2503
12 (300)	Epoxy Black	5	507 3003
14 (350)	Epoxy Black	5	507 3503
16 (400)	Epoxy Black	5	507 4003
18 (450)	Epoxy Black	5	507 4503
20 (500)	Epoxy Black	5	507 5003
24 (600)	Epoxy Black	2	507 6003
30 (750)	Epoxy Black	2	507 7503
36 (900)	Epoxy Black	2	507 9003

Includes fixings.

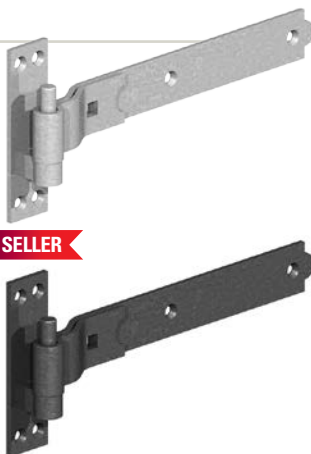

Hinges



GATEMATE ADJUSTABLE BANDS AND HOOKS ON PLATES

SIZE ins (mm)	FINISH	PAIRS/BOX	CODE
14 (350)	Galvanised	5	508 3501
18 (450)	Galvanised	5	508 4501
24 (600)	Galvanised	2	508 6001
30 (750)	Galvanised	2	508 7501
36 (900)	Galvanised	1	508 9001
14 (350)	Epoxy Black	5	508 3503
18 (450)	Epoxy Black	5	508 4503
24 (600)	Epoxy Black	2	508 6003
30 (750)	Epoxy Black	2	508 7503
36 (900)	Epoxy Black	1	508 9003

Includes fixings.

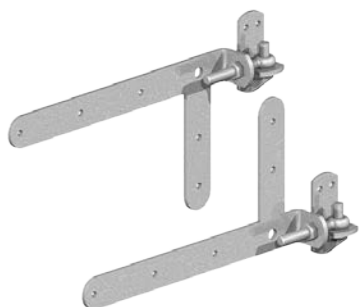

GATEMATE BRACED ADJUSTABLE BANDS AND HOOKS ON PLATES

SIZE ins (mm)	FINISH	PAIRS/BOX	CODE
14 (350)	Galvanised	5	598 0101

Includes fixings.

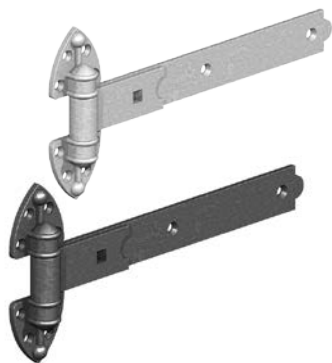

GATEMATE HEAVY REVERSIBLE HINGES

SIZE ins (mm)	FINISH	PAIRS/BOX	CODE
12 (300)	Galvanised	5	509 3001
14 (350)	Galvanised	5	509 3501
16 (400)	Galvanised	5	509 4001
18 (450)	Galvanised	5	509 4501
20 (500)	Galvanised	5	509 5001
24 (600)	Galvanised	2	509 6001
30 (750)	Galvanised	2	509 7501
36 (900)	Galvanised	2	509 9001
12 (300)	Epoxy Black	5	509 3003
14 (350)	Epoxy Black	5	509 3503
16 (400)	Epoxy Black	5	509 4003
18 (450)	Epoxy Black	5	509 4503
20 (500)	Epoxy Black	5	509 5003
24 (600)	Epoxy Black	2	509 6003
30 (750)	Epoxy Black	2	509 7503
36 (900)	Epoxy Black	2	509 9003

Includes fixings.



GATEMATE BUTT HINGES 1838

SIZE ins (mm)	FINISH	PAIRS/BOX	CODE
2 (50)	Zinc Plated	5	504 0502
3 (75)	Zinc Plated	5	504 0752
4 (100)	Zinc Plated	5	504 1002
6 (150)	Zinc Plated	5	504 1502

Includes fixings.

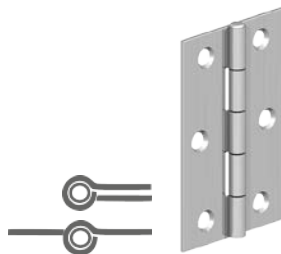

GATEMATE STRONG BUTT HINGES

SIZE ins (mm)	FINISH	PAIRS/BOX	CODE
4 (100)	Zinc Plated	5	545 1002

Includes fixings.

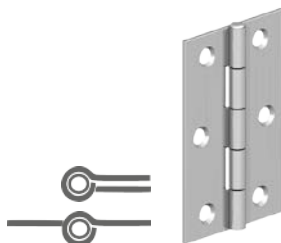

GATEMATE CLASS 9 STAINLESS STEEL BALL BEARING BUTT HINGES

SIZE ins (mm)	FINISH	PAIRS/BOX	CODE
3x2 (75x50)	Polished Stainless Steel	1	027 0756P
3x2 (75x50)	Brushed Stainless Steel	1	027 0756B

For indoor use on timber doors.
High quality smooth ball bearing action.
Includes stainless steel screws.



GATEMATE CLASS 13 STAINLESS STEEL BALL BEARING BUTT HINGES

SIZE ins (mm)	FINISH	PAIRS/BOX	CODE
4x3 (100x75)	Polished Stainless Steel	1	027 1006P
4x3 (100x75)	Brushed Stainless Steel	1	027 1006B
4x3 (100x75)	Polished Stainless Steel	1.5	027 1016P
4x3 (100x75)	Brushed Stainless Steel	1.5	027 1016B

Certified to CE13 BSN1935.
Includes stainless steel screws.
Certifire approved product.
Quality and performance: BS EN 1935.
Fire safety: BS EN 1634. For use on 30 minute and 1 hour fire doors.



Latches, Catches and Bolts

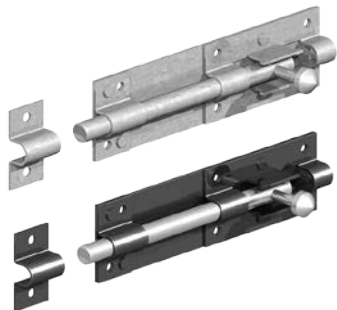

GATEMATE TOWER BOLT

SIZE ins (mm)	FINISH	QTY/BOX	CODE
3 (75)	Galvanised	5	510 0751
4 (100)	Galvanised	5	510 1001
6 (150)	Galvanised	5	510 1501
8 (200)	Galvanised	5	510 2001
10 (250)	Galvanised	5	510 2501
4 (100)	Zinc Plated	5	510 1002
6 (150)	Zinc Plated	5	510 1502
8 (200)	Zinc Plated	5	510 2002
10 (250)	Zinc Plated	5	510 2502
3 (75)	Epoxy Black	5	510 0753
4 (100)	Epoxy Black	5	510 1003
6 (150)	Epoxy Black	5	510 1503
8 (200)	Epoxy Black	5	510 2003
10 (250)	Epoxy Black	5	510 2503

Includes fixings.

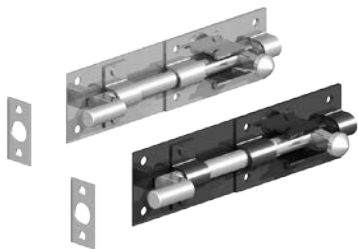

GATEMATE NECKED TOWER BOLT

SIZE ins (mm)	FINISH	QTY/BOX	CODE
6 (150)	Galvanised	5	511 1501
6 (150)	Epoxy Black	5	511 1503

Includes fixings.

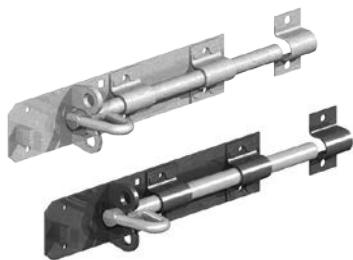

GATEMATE BRENTON PADBOLT 1/2" SHOOT

SIZE ins (mm)	FINISH	QTY/BOX	CODE
4 (100)	Galvanised	5	512 1001
6 (150)	Galvanised	5	512 1501
8 (200)	Galvanised	5	512 2001
10 (250)	Galvanised	5	512 2501
4 (100)	Zinc Plated	5	512 1002
6 (150)	Zinc Plated	5	512 1502
8 (200)	Zinc Plated	5	512 2002
4 (100)	Epoxy Black	5	512 1003
6 (150)	Epoxy Black	5	512 1503
8 (200)	Epoxy Black	5	512 2003

Includes fixings.



GATEMATE BRENTON PADBOLT 5/8" SHOOT

SIZE ins (mm)	FINISH	QTY/BOX	CODE
6 (150)	Galvanised	5	513 1501
8 (200)	Galvanised	5	513 2001
10 (250)	Galvanised	5	513 2501
12 (300)	Galvanised	5	513 3001

Includes fixings.

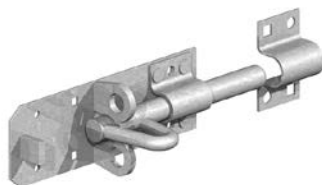

GATEMATE BRENTON PADBOLT 5/8" SHOOT WITH ELONGATED KEEP

SIZE ins (mm)	FINISH	QTY/BOX	CODE
6 (150)	Galvanised	5	513 1511
8 (200)	Galvanised	5	513 2011

Includes fixings.

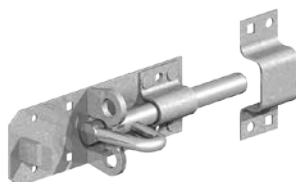

GATEMATE BRENTON PADBOLT KIT WITH 2" PADLOCK

SIZE ins (mm)	FINISH	QTY/BOX	CODE
6x1/2 (150x12)	Galvanised	5	512 1511
6x1/2 (150x12)	Zinc Plated	5	512 1512

Includes fixings.



GATEMATE HEAVY CROSS PATTERN DOOR BOLT

SIZE ins (mm)	FINISH	QTY/BOX	CODE
12 (300)	Galvanised	5	527 3001
15 (375)	Galvanised	5	527 3751
18 (450)	Galvanised	5	527 4501
24 (600)	Galvanised	5	527 6001

Includes fixings.



GATEMATE OVAL PADBOLT

SIZE ins (mm)	FINISH	QTY/BOX	CODE
4 (100)	Galvanised	5	514 1001
4 (100)	Zinc Plated	5	514 1002
4 (100)	Epoxy Black	5	514 1003

Includes fixings.



Latches, Catches and Bolts

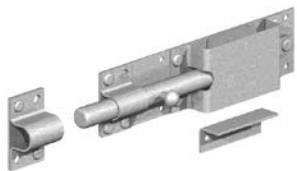

GATEMATE AUTOLOCK ANIMAL BOLT

SIZE ins (mm)	FINISH	QTY/BOX	CODE
9 (230)	Galvanised	5	515 2301

Includes fixings.

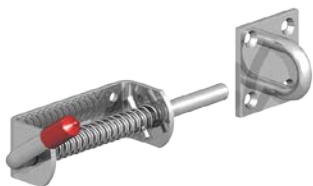

GATEMATE SPRING LOADED ANIMAL BOLT

SIZE ins (mm)	FINISH	QTY/BOX	CODE
1/2x4 1/2 (12x115)	Zinc Plated	5	516 0122

Size = shoot diameter x length.

Includes fixings.



GATEMATE SPRING LOADED BOLT

SIZE ins (mm)	FINISH	QTY/BOX	CODE
3/8x2 3/4 (9.5x70)	Zinc Plated	5	516 1952
1/2x4 1/2 (12x115)	Zinc Plated	5	516 1122
5/8x4 (16x105)	Zinc Plated	5	516 1162

Size = shoot diameter x length.

Includes fixings.

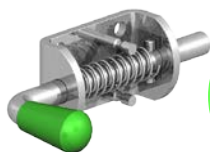

GATEMATE SPRING LOADED BOLT SHORT BODY

SIZE ins (mm)	FINISH	QTY/BOX	CODE
3/8x2 1/2 (9.5x60)	Zinc Plated	5	516 3952
1/2x3 (12x75)	Zinc Plated	5	516 3122

Size = shoot diameter x length

Includes fixings.



GATEMATE CHAIN BOLT

SIZE ins (mm)	FINISH	QTY/BOX	CODE
8 (200)	Zinc Plated	5	517 2002
8 (200)	Epoxy Black	5	517 2003

Includes fixings.



GATEMATE FOOT BOLT

SIZE ins (mm)	FINISH	QTY/BOX	CODE
8 (200)	Zinc Plated	5	518 2002
8 (200)	Epoxy Black	5	518 2003

Includes fixings.



GATEMATE MONKEY TAIL BOLT 5/8" SQUARE SHOOT

SIZE ins (mm)	FINISH	QTY/BOX	CODE
12 (300)	Zinc Plated	5	519 3001
18 (450)	Epoxy Black	5	519 4501
12 (300)	Zinc Plated	5	519 3003
18 (450)	Epoxy Black	5	519 4503

Includes fixings.



GATEMATE BOW HANDLE BOLT 5/8" SQUARE SHOOT

SIZE ins (mm)	FINISH	QTY/BOX	CODE
12 (300)	Galvanised	5	576 3001
18 (450)	Galvanised	5	576 4501
24 (600)	Galvanised	5	576 6001

Includes fixings.



GATEMATE CANE BOLT

SIZE ins (mm)	FINISH	QTY/BOX	CODE
12 (300)	Zinc Plated	5	602 0042
18 (450)	Zinc Plated	5	602 0032

Includes fixings.



Latches, Catches and Bolts

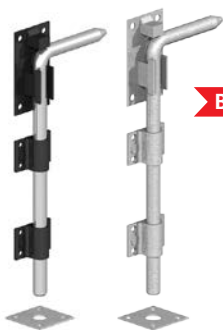

GATEMATE GARAGE DOOR BOLT

SIZE ins (mm)	FINISH	QTY/BOX	CODE
12 (300)	Galvanised	5	520 3001
18 (450)	Galvanised	5	520 4501
24 (600)	Galvanised	5	520 6001
12 (300)	Epoxy Black	5	520 3003
18 (450)	Epoxy Black	5	520 4503
24 (600)	Epoxy Black	5	520 6003

Includes fixings.



GATEMATE HEAVY DUTY ORNAMENTAL DROP BOLT

SIZE ins (mm)	FINISH	QTY/BOX	CODE
24x $\frac{5}{8}$ (600x16)	Galvanised	5	518 6001
24x $\frac{5}{8}$ (600x16)	Epoxy Black	5	518 6003

Includes fixings.



GATEMATE HEAVY LOCKING GARAGE DOOR BOLT

SIZE ins (mm)	FINISH	QTY/BOX	CODE
18x $\frac{5}{8}$ (450x16)	Galvanised	5	517 4501

Size = Shoot diameter x Length.

Includes fixings.

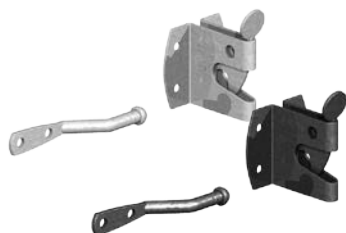

GATEMATE AUTO GATE CATCH

SIZE	FINISH	QTY/BOX	CODE
Medium	Galvanised	5	521 0011
Medium	Zinc Plated	5	521 0012
Medium	Epoxy Black	5	521 0013
Large	Galvanised	5	521 0021
Large	Epoxy Black	5	521 0023

Includes fixings.



GATEMATE EASY CLOSE AUTO CATCH

SIZE ins (mm)	FINISH	QTY/BOX	CODE
2 (50)	Galvanised	5	601 0011
2 (50)	Zinc Plated	5	601 0012
2 (50)	Epoxy Black	5	601 0013

Ideal for use with narrow gate stiles.
Includes fixings.



GATEMATE SUFFOLK LATCH

SIZE	FINISH	QTY/BOX	CODE
Light	Zinc Plated	5	523 0012
Light	Epoxy Black	5	523 0013
Heavy	Galvanised	5	523 0021
Heavy	Zinc Plated	5	523 0022
Heavy	Epoxy Black	5	523 0023

Includes fixings.



GATEMATE GOTHIC SUFFOLK LATCH

SIZE	FINISH	QTY/BOX	CODE
Heavy	Galvanised	5	523 0031
Heavy	Zinc Plated	5	523 0032
Heavy	Epoxy Black	5	523 0033

Includes fixings.

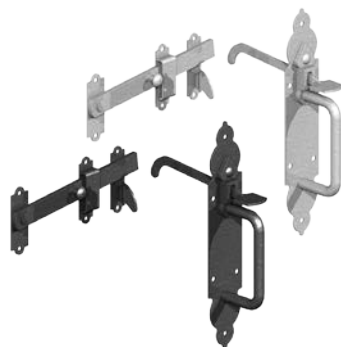

GATEMATE TWISTED RING GATE LATCH

SIZE ins (mm)	FINISH	QTY/BOX	CODE
6 (150)	Galvanised	5	524 1501
6 (150)	Epoxy Black	5	524 1503

Includes fixings.



Latches, Catches and Bolts



GATEMATE RING GATE LATCH

SIZE ins (mm)	FINISH	QTY/BOX	CODE
4 (100)	Galvanised	5	525 1001
5 (125)	Galvanised	5	525 1251
6 (150)	Galvanised	5	525 1501
7 (175)	Galvanised	5	525 1751
5 (125)	Zinc Plated	5	525 1252
6 (150)	Zinc Plated	5	525 1502
5 (125)	Epoxy Black	5	525 1253
6 (150)	Epoxy Black	5	525 1503
7 (175)	Epoxy Black	5	525 1753

Includes fixings.



GATEMATE PLAIN RING HANDLE ONLY

SIZE ins (mm)	FINISH	QTY/BOX	CODE
2½ (65)	Galvanised	5	526 0001
2½ (65)	Epoxy Black	5	526 0003

Includes fixings.



GATEMATE KENHAM GATE CATCH

SIZE ins (mm)	FINISH	QTY/BOX	CODE
3 (75)	Zinc Plated	5	566 0752

Includes fixings.



GATEMATE GATE RETURN SPRING

SIZE ins (mm)	FINISH	QTY/BOX	CODE
8 (200)	Zinc Plated	5	526 2002
10 (250)	Zinc Plated	5	526 2502
8 (200)	Epoxy Black	5	526 2003
10 (250)	Epoxy Black	5	526 2503

Includes fixings.



GATEMATE TURN BUTTONS (PACK OF 2)

SIZE ins (mm)	FINISH	QTY/BOX	CODE
2 (50)	Zinc Plated	5	527 0502
2 (50)	Epoxy Black	5	527 0503

Includes fixings.



GATEMATE DOOR-GATE STOP

SIZE ins (mm)	FINISH	QTY/BOX	CODE
6 (150)	Epoxy Grey	5	531 1503

Includes fixings.



GATEMATE CABIN HOOK WIRE PATTERN

SIZE ins (mm)	FINISH	QTY/BOX	CODE
4 (100)	Galvanised	5	532 1001
6 (150)	Galvanised	5	532 1501
8 (200)	Galvanised	5	532 2001
10 (250)	Galvanised	5	532 2501
12 (300)	Galvanised	5	532 3001
24 (600) heavy duty	Galvanised	5	532 6001
4 (100)	Epoxy Black	5	532 1003
6 (150)	Epoxy Black	5	532 1503
8 (200)	Epoxy Black	5	532 2003
12 (300)	Epoxy Black	5	532 3003
24 (600) heavy duty	Epoxy Black	5	532 6003

Includes fixings.

BEST SELLER



GATEMATE CABIN HOOK CAST PATTERN

SIZE ins (mm)	FINISH	QTY/BOX	CODE
4 (100)	Galvanised	5	541 1001
6 (150)	Galvanised	5	541 1501
8 (200)	Galvanised	5	541 2001
10 (250)	Galvanised	5	541 2501
4 (100)	Epoxy Black	5	541 1003
6 (150)	Epoxy Black	5	541 1503
8 (200)	Epoxy Black	5	541 2003
10 (250)	Epoxy Black	5	541 2503

Includes fixings.



GATEMATE KICK OVER STABLE LATCH

SIZE ins (mm)	FINISH	QTY/BOX	CODE
9½ (240)	Galvanised	5	530 2401

Includes fixings.

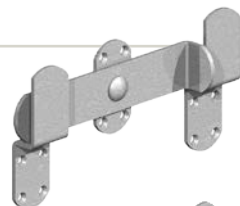

GATEMATE NARROW PATTERN KICK OVER STABLE LATCH

SIZE ins (mm)	FINISH	QTY/BOX	CODE
9½ (240)	Galvanised	5	530 2451

Includes fixings.

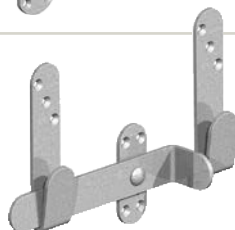

Gate Signs and Reflectors



GATEMATE GATE SIGNS

DESCRIPTION	SIZE mm	FINISH	QTY/BOX	CODE
Please shut the gate	160x55	Brass	5	544 0005
Please shut the gate	160x55	Chrome	5	544 000C
Beware of the dog	160x55	Brass	5	544 0015
Beware of the dog	160x55	Chrome	5	544 001C

Includes fixings.

NEW



GATEMATE HIGH VISIBILITY REFLECTORS (PACK OF 2)

SIZE mm	COLOUR	QTY/BOX	CODE
110x45mm	Red	5	859 110R
110x45mm	White	5	859 110W

Includes fixings.

Locking Bars and Hasp & Staples

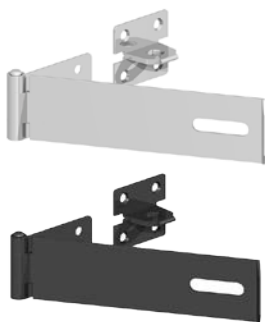

GATEMATE SAFETY PATTERN HASP AND STAPLE

SIZE ins (mm)	FINISH	QTY/BOX	CODE
3 (75)	Zinc Plated	5	533 0752
4 (100)	Zinc Plated	5	533 1002
6 (150)	Zinc Plated	5	533 1502
3 (75)	Epoxy Black	5	533 0753
4 (100)	Epoxy Black	5	533 1003
6 (150)	Epoxy Black	5	533 1503

Includes fixings.

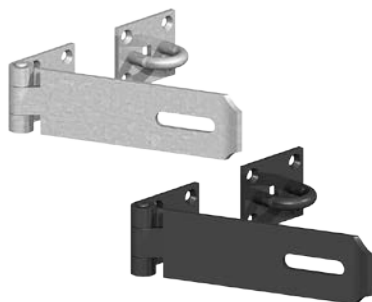

GATEMATE HEAVY SAFETY PATTERN HASP AND STAPLE

SIZE ins (mm)	FINISH	QTY/BOX	CODE
7 (180)	Galvanised	5	538 1801
7 (180)	Epoxy Black	5	538 1803

Includes fixings.



GATEMATE VERTICAL PATTERN HEAVY HASP AND STAPLE

SIZE ins (mm)	FINISH	QTY/BOX	CODE
6 (150)	Galvanised	5	534 1501
6 (150)	Epoxy Black	5	534 1503

Includes fixings.



GATEMATE HEAVY HASP AND STAPLE

SIZE ins (mm)	FINISH	QTY/BOX	CODE
8 (200)	Galvanised	5	535 2001
10 (250)	Galvanised	5	535 2501
8 (200)	Epoxy Black	5	535 2003
10 (250)	Epoxy Black	5	535 2503

Includes fixings.

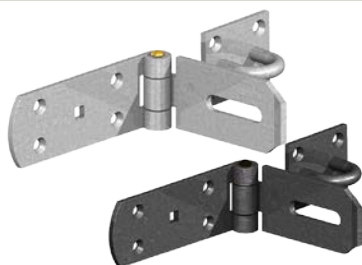

GATEMATE LOCKING BARS TO SWIVEL

SIZE ins (mm)	FINISH	QTY/BOX	CODE
8 (200)	Galvanised	5	536 2001

Includes fixings.



NEW

GATEMATE WIRE PATTERN HASP AND STAPLE

SIZE ins (mm)	FINISH	QTY/BOX	CODE
4 (100)	Zinc Plated	5	536 1002
6 (150)	Zinc Plated	5	536 1502
3 (75)	Epoxy Black	5	536 0753
4 (100)	Epoxy Black	5	536 1003
6 (150)	Epoxy Black	5	536 1503

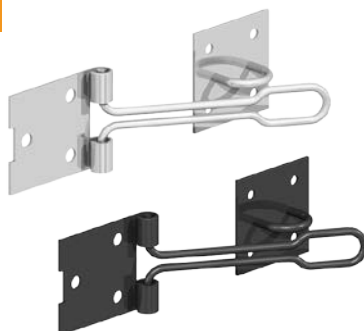

Stainless Steel

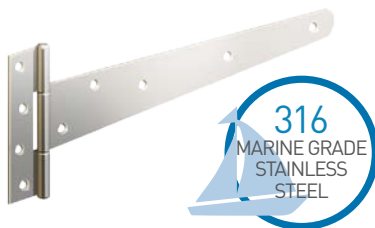

GATEMATE STAINLESS STEEL WEIGHTY SCOTCH TEE HINGES

SIZE ins (mm)	FINISH	PAIRS/BOX	CODE
8 (200)	Stainless Steel	1	505 2006
12 (300)	Stainless Steel	1	505 3006

Includes fixings.



GATEMATE STAINLESS STEEL STRAIGHT BANDS AND HOOKS ON PLATES

SIZE ins (mm)	FINISH	PAIRS/BOX	CODE
18 (450)	Stainless Steel	1	506 4506
24 (600)	Stainless Steel	1	506 6006
36 (900)	Stainless Steel	1	506 9006

Includes fixings.



GATEMATE STAINLESS STEEL CRANKED BANDS AND HOOKS ON PLATES

SIZE ins (mm)	FINISH	PAIRS/BOX	CODE
18 (450)	Stainless Steel	1	507 4506
24 (600)	Stainless Steel	1	507 6006
36 (900)	Stainless Steel	1	507 9006

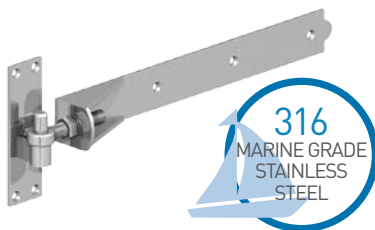

GATEMATE STAINLESS STEEL ADJUSTABLE BANDS AND HOOKS ON PLATES

SIZE ins (mm)	FINISH	PAIRS/BOX	CODE
18 (450)	Stainless Steel	1	508 4506
24 (600)	Stainless Steel	1	508 6006
36 (900)	Stainless Steel	1	508 9006

Includes fixings.



GATEMATE STAINLESS STEEL HEAVY LOCKING GARAGE DOOR BOLT

SIZE ins (mm)	FINISH	PAIRS/BOX	CODE
18x $\frac{9}{8}$ (450x16)	Stainless Steel	1	517 4506

Includes fixings.



GATEMATE STAINLESS STEEL BRENTON PADBOLT 1/2" SHOOT

SIZE ins (mm)	FINISH	QTY/BOX	CODE
6x1/2 (150x12)	Stainless Steel	1	512 1506

Includes fixings.



316
MARINE GRADE
STAINLESS
STEEL

GATEMATE STAINLESS STEEL BRENTON PADBOLT 5/8" SHOOT

SIZE ins (mm)	FINISH	QTY/BOX	CODE
8x5/8 (200x16)	Stainless Steel	1	513 2006

Includes fixings.

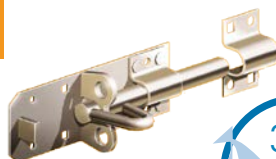

316
MARINE GRADE
STAINLESS
STEEL

GATEMATE STAINLESS STEEL RING GATE LATCH

SIZE ins (mm)	FINISH	QTY/BOX	CODE
6 (150)	Stainless Steel	1	525 1506

Includes fixings.



316
MARINE GRADE
STAINLESS
STEEL

GATEMATE STAINLESS STEEL GOTHIC SUFFOLK LATCH

SIZE	FINISH	QTY/BOX	CODE
Heavy	Stainless Steel	1	523 0036

Includes fixings.



316
MARINE GRADE
STAINLESS
STEEL

GATEMATE STAINLESS STEEL CABIN HOOK

SIZE ins (mm)	FINISH	QTY/BOX	CODE
4 (100)	Stainless Steel	5	541 1006

Includes fixings.



316
MARINE GRADE
STAINLESS
STEEL

Premium Black

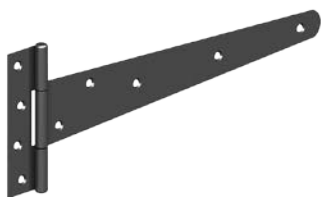

GATEMATE PREMIUM BLACK STRONG TEE HINGES

SIZE ins (mm)	FINISH	PAIRS/BOX	CODE
18 (450)	Polyester black on galvanised	5	503 450B
24 (600)	Polyester black on galvanised	5	503 600B

Includes fixings.

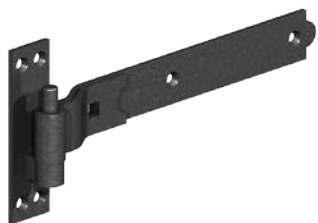

GATEMATE PREMIUM BLACK CRANKED BANDS AND HOOKS ON PLATES

SIZE ins (mm)	FINISH	PAIRS/BOX	CODE
18 (450)	Polyester black on galvanised	5	507 450B
24 (600)	Polyester black on galvanised	2	507 600B
30 (750)	Polyester black on galvanised	2	507 750B
36 (900)	Polyester black on galvanised	2	507 900B

Includes fixings.



GATEMATE PREMIUM BLACK ADJUSTABLE BANDS AND HOOKS ON PLATES

SIZE ins (mm)	FINISH	PAIRS/BOX	CODE
18 (450)	Polyester black on galvanised	5	508 450B
24 (600)	Polyester black on galvanised	2	508 600B
30 (750)	Polyester black on galvanised	2	508 750B
36 (900)	Polyester black on galvanised	1	508 900B

Includes fixings.

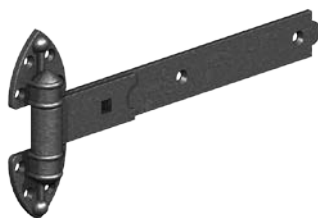

GATEMATE PREMIUM BLACK HEAVY REVERSIBLE HINGES

SIZE ins (mm)	FINISH	PAIRS/BOX	CODE
18 (450)	Polyester black on galvanised	5	509 450B
24 (600)	Polyester black on galvanised	2	509 600B
36 (900)	Polyester black on galvanised	2	509 900B

Includes fixings.



GATEMATE PREMIUM BLACK BRENTON PADBOLT 1/2" SHOOT

SIZE ins (mm)	FINISH	QTY/BOX	CODE
6x1/2 (150x12)	Polyester black on galvanised	5	512 150B
8x1/2 (200x12)	Polyester black on galvanised	5	512 200B

Includes fixings.



GATEMATE PREMIUM BLACK GARAGE DOOR BOLT

SIZE ins (mm)	FINISH	QTY/BOX	CODE
18 (450)	Polyester black on galvanised	5	520 450B

Includes fixings.



GATEMATE PREMIUM BLACK RING GATE LATCH

SIZE ins (mm)	FINISH	PAIRS/BOX	CODE
5 (125)	Polyester black on galvanised	5	525 125B
6 (150)	Polyester black on galvanised	5	525 150B

Includes fixings.



GATEMATE PREMIUM BLACK SUFFOLK LATCH

SIZE	FINISH	QTY/BOX	CODE
Heavy	Polyester black on galvanised	5	523 002B

Includes fixings.

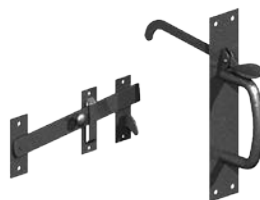

GATEMATE PREMIUM BLACK CABIN HOOK CAST PATTERN

SIZE ins (mm)	FINISH	QTY/BOX	CODE
8 (200)	Polyester black on galvanised	5	541 200B

Includes fixings.



Ornamental

GATEMATE ORNAMENTAL TEE HINGES

SIZE ins (mm)	FINISH	PAIRS/BOX	CODE
6 (150)	Dull black	5	550 1503
9 (225)	Dull black	5	550 2253
12 (300)	Dull black	5	550 3003

Includes fixings.



Ornamental

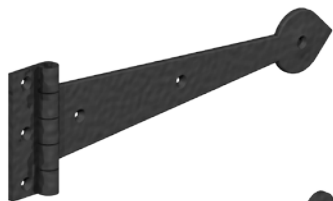

GATEMATE ORNAMENTAL HEAVY DUTY TEE HINGES

SIZE ins (mm)	FINISH	PAIRS/BOX	CODE
12 (300)	Dull black	5	574 3003
14 (350)	Dull black	5	574 3503
16 (400)	Dull black	5	574 4003
18 (450)	Dull black	5	574 4503

Includes fixings.



GATEMATE ORNAMENTAL FLEUR DE LEYS HINGES

SIZE ins (mm)	FINISH	PAIRS/BOX	CODE
12 (300)	Dull black	5	551 3003

Includes fixings.



GATEMATE ORNAMENTAL BUTTERFLY HINGES

SIZE ins (mm)	FINISH	PAIRS/BOX	CODE
2¾x2 (70x50)	Dull black	5	552 7053

Includes fixings.



GATEMATE ORNAMENTAL UNEQUAL HINGES

SIZE ins (mm)	FINISH	PAIRS/BOX	CODE
4x3 (100x75)	Dull black	5	553 1003

Includes fixings.



GATEMATE ORNAMENTAL HOOK AND BAND HINGES

SIZE ins (mm)	FINISH	PAIRS/BOX	CODE
12 (300)	Dull black	1	563 3003
18 (450)	Dull black	1	563 4503
24 (600)	Dull black	1	563 6003

Includes fixings.



GATEMATE ORNAMENTAL LEVER LOCK HANDLE

SPINDLE LENGTH ins (mm)	SIZE ins (mm)	FINISH	PAIRS/BOX	CODE
3 (75)	6x2 (150x50)	Dull black	5	555 1503

Includes fixings.



GATEMATE ORNAMENTAL FLEUR DE LEYS LEVER LOCK HANDLE

SPINDLE LENGTH ins (mm)	SIZE ins (mm)	FINISH	PAIRS/BOX	CODE
3 [75]	7x2 [175x50]	Dull black	5	556 1753

Includes fixings.



GATEMATE ORNAMENTAL STRAIGHT DOOR BOLT

SIZE ins (mm)	FINISH	QTY/BOX	CODE
6 [150]	Dull black	5	557 1503
8 [200]	Dull black	5	557 2003

Includes fixings.



GATEMATE ORNAMENTAL CASEMENT STAY

SIZE ins (mm)	FINISH	QTY/BOX	CODE
10 [250]	Dull black	5	558 2503

Includes fixings.



GATEMATE ORNAMENTAL CABIN HOOK CAST PATTERN

SIZE ins (mm)	FINISH	QTY/BOX	CODE
4 [100]	Dull black	5	559 1003
6 [150]	Dull black	5	559 1503

Includes fixings.



GATEMATE ORNAMENTAL FLEUR DE LEYS DOOR HANDLE

SIZE ins (mm)	FINISH	QTY/BOX	CODE
4 [100]	Dull black	5	560 1003
7 [175]	Dull black	5	560 1753

Includes fixings.



GATEMATE ORNAMENTAL HEAVY DOOR PULL

SIZE ins (mm)	FINISH	QTY/BOX	CODE
10 [250]	Dull black	5	568 2503

Includes fixings.



GATEMATE ORNAMENTAL DOOR STUDS (PACK OF 10)

SIZE ins (mm)	FINISH	QTY/BOX	CODE
3/4 [19]	Dull black	5	562 0193



Ornamental



GATEMATE ORNAMENTAL LION DOOR KNOCKER

SIZE ins (mm)	FINISH	QTY/BOX	CODE
4 (100)	Dull black	5	569 0003

Includes fixings.



GATEMATE ORNAMENTAL NUMERALS

DESCRIPTION	SIZE ins (mm)	FINISH	QTY/BOX	CODE
No. 0	3 (75)	Dull black	5	570 0030
No. 1	3 (75)	Dull black	5	570 0031
No. 2	3 (75)	Dull black	5	570 0032
No. 3	3 (75)	Dull black	5	570 0033
No. 4	3 (75)	Dull black	5	570 0034
No. 5	3 (75)	Dull black	5	570 0035
No. 6	3 (75)	Dull black	5	570 0036
No. 7	3 (75)	Dull black	5	570 0037
No. 8	3 (75)	Dull black	5	570 0038
No. 9	3 (75)	Dull black	5	570 0039

Includes fixings.

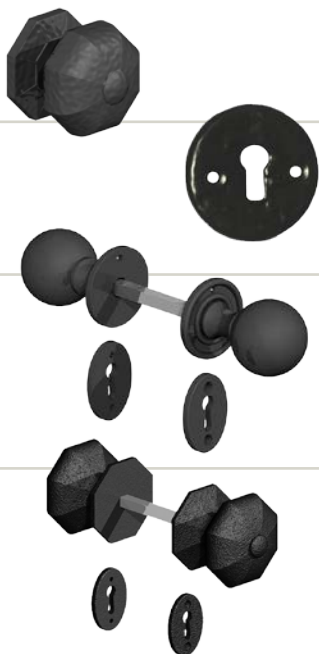

GATEMATE ORNAMENTAL OCTAGONAL DOOR KNOB

SIZE ins (mm)	FINISH	QTY/BOX	CODE
3 (75)	Dull black	5	572 0003

GATEMATE ORNAMENTAL ESCUTCHEON PLATE

SIZE ins (mm)	FINISH	QTY/BOX	CODE
1½ (38)	Dull black	5	567 0003

Includes fixings.

GATEMATE ORNAMENTAL CAST BALL KNOB FURNITURE

SPINDLE LENGTH ins (mm)	SIZE ins (mm)	FINISH	QTY/BOX	CODE
3 (75)	1¾ (45)	Dull black	5	575 0453

Includes fixings.

GATEMATE ORNAMENTAL CAST OCTAGONAL DOOR FURNITURE

SPINDLE LENGTH ins (mm)	SIZE ins (mm)	FINISH	QTY/BOX	CODE
3 (75)	2 (50)	Dull black	5	575 0503

Includes fixings.



GATEMATE ORNAMENTAL CAST OVAL DOOR FURNITURE

SPINDLE LENGTH ins (mm)	SIZE ins (mm)	FINISH	QTY/BOX	CODE
3 (75)	2 (50)	Dull black	5	575 0603

Includes fixings.



GATEMATE ORNAMENTAL RING GATE LATCH

SIZE ins (mm)	FINISH	QTY/BOX	CODE
8 (200)	Dull black	5	561 2003
10 (250)	Dull black	5	561 2503
8 (200)	Galvanised	5	561 2001
10 (250)	Galvanised	5	561 2501

Includes fixings.



GATEMATE ORNAMENTAL RING HANDLE ONLY

SIZE ins (mm)	FINISH	QTY/BOX	CODE
4 (100)	Dull black	5	561 2003A
4 (100)	Galvanised	5	561 2001A

Includes fixings.



GATEMATE ORNAMENTAL SUFFOLK LATCH

SIZE ins (mm)	FINISH	QTY/BOX	CODE
6 (150)	Dull black	5	564 1503

Includes fixings.



GATEMATE ORNAMENTAL LETTER PLATE

SIZE ins (mm)	FINISH	QTY/BOX	CODE
10x3 (250x75)	Dull black	5	565 2503

Includes fixings.

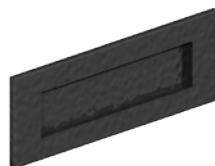

GATEMATE ORNAMENTAL FLEUR DE LEYS LETTER PLATE

SIZE ins (mm)	FINISH	QTY/BOX	CODE
13x3¼ (330x85)	Dull black	5	566 2503

Includes fixings.

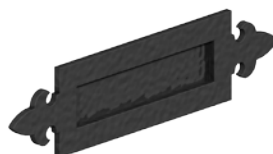

High Performance Composite Hinges

Our safety gate hinges are injection-moulded from super strong glass-fibre reinforced materials for many years of reliable and rust-free performance. The unique, spring-loaded adjuster allows tension to be quickly adjusted for gates of different sizes and weights using only a screwdriver.



GATEMATE STANDARD UNSPRUNG GATE HINGES

SIZE mm	FINISH	QTY/BOX	CODE
90x70	Polymer	1	8911F13
110x75	Polymer	1	8911F23

Suitable for 25-50mm posts.
Includes fixings.



GATEMATE FIXED SPRING SELF CLOSING HINGES WITH LEGS

SIZE mm	FINISH	QTY/BOX	CODE
110x75	Polymer	1	8931F23

Suitable for 40-75mm posts.
Includes fixings.



GATEMATE SELF CLOSING HINGES WITH LEGS

SIZE mm	FINISH	QTY/BOX	CODE
108x63.5	Polymer	1	8941F23

Max closing weight 25kg.
Includes fixings.



GATEMATE SELF CLOSING HINGES WITHOUT LEGS

SIZE mm	FINISH	QTY/BOX	CODE
108x63.5	Polymer	1	8940V23

Max closing weight 25kg; suitable for 25-50mm posts.
Includes fixings.



GATEMATE ADJUSTABLE SELF CLOSING OFFSET HINGES WITH LEGS

DESCRIPTION	SIZE mm	FINISH	QTY/BOX	CODE
Hinge	108x105	Polymer	1	8941A33
Round post adaptor		Polymer	1	8941A53

Max closing weight 25kg; suitable for 40-100mm posts.



GATEMATE SELF CLOSING HINGES WITH LEGS

SIZE mm	FINISH	QTY/BOX	CODE
108x158	Polymer	1	8941F43

To suit 50-100mm post.
Max closing weight 25kg, suitable for 25-50mm posts.
Includes fixings.



GATEMATE OFFSET SELF CLOSING HINGES WITH LEGS

SIZE mm	FINISH	QTY/BOX	CODE
108x110	Polymer	1	8941F83

Max closing weight 25kg; suitable for 75-100mm posts and 25-50mm gate stile.
Includes fixings.



GATEMATE HEAVY DUTY SELF CLOSING HINGES

SIZE mm	FINISH	QTY/BOX	CODE
125x90	Polymer	1	8941F53

Max closing weight 60kg; suitable for 35-75mm posts.
Includes fixings.



GATEMATE SELF CLOSING HINGES WITH ONE LEG AND HORIZONTAL ADJUSTMENT

SIZE mm	FINISH	QTY/BOX	CODE
108x168	Polymer	1	8941H53

Max closing weight 25kg; suitable for 75-100mm posts.
Includes fixings.



GATEMATE HEAVY DUTY ADJUSTABLE SELF CLOSING HINGES

SIZE mm	FINISH	QTY/BOX	CODE
125x178	Polymer	1	8941A73

Max closing weight 60kg; suitable for 50-100mm posts.
With horizontal and vertical adjustment.
Includes fixings.



High Performance Composite Latches, Catches and Bolts



GATEMATE PRO DOUBLE LOCKING GRAVITY LATCH

Elegant design and high security with double hook mechanism. The lock has vertical adjustment allowing easy installation and alignment.

DESCRIPTION	FINISH	QTY/BOX	CODE
Standard	Polymer	1	8961D73
Keyed alike	Polymer	1	8961D73KA

Includes fixings.



GATEMATE GRAVITY LATCH

A general purpose key lockable catch. Available in single or double locking, allowing the gate to be locked from both sides.

DESCRIPTION	FINISH	QTY/BOX	CODE
Single locking	Polymer	1	8961S53
Double locking	Polymer	1	8961D53
Single locking keyed alike	Polymer	1	8961S53KA
Double locking keyed alike	Polymer	1	8961D53KA
Round post adaptor	Polymer	1	89A1F33

Includes fixings.



GATEMATE MANTA MAGNETIC LATCH

FINISH	QTY/BOX	CODE
Polymer	1	8981D43

Includes fixings.



GATEMATE MAGNETIC SIDE PULL

FINISH	QTY/BOX	CODE
Polymer	1	8980S13

Includes fixings.



GATEMATE CHILD SAFETY LATCH

DESCRIPTION	SIZE ins (mm)	FINISH	QTY/BOX	CODE
Long	20 (500)	Polymer	1	8981S33
Short	10 (250)	Polymer	1	8981S23
Round post adaptor	108x105	Polymer	1	89A1F43

Includes fixings.



GATEMATE MANTA MAGNETIC LATCH

FINISH	QTY/BOX	CODE
Polymer	1	8991D43

Includes fixings.



GATEMATE STAINLESS STEEL DROP BOLT

SIZE ins (mm)	FINISH	QTY/BOX	CODE
18 (450)	Polymer	1	8961B83
24 (600)	Polymer	1	8961B93

Key lockable. Includes fixings.



Hi Performance Metal Self Closing Hinges

GATEMATE ALUMINIUM SELF CLOSING HINGES

SIZE mm	FINISH	QTY/BOX	CODE
146x89	Black with legs	1	8921F43
146x89	Black without legs	1	8921F33

Includes fixings.



GATEMATE ORNAMENTAL HEAVY DUTY STEEL SELF CLOSING HINGES

SIZE mm	FINISH	QTY/BOX	CODE
8 (200)	Black	1	8950F53

Max weight 60kg.

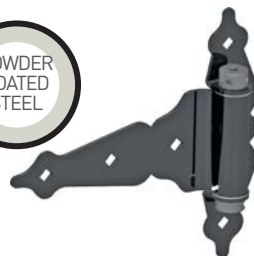

High Performance Zinc Alloy Gravity Latches

GATEMATE ZINC ALLOY GRAVITY LATCH

DESCRIPTION	FINISH	QTY/BOX	CODE
Single locking	Black	1	8971S53
Single locking, keyed alike	Black	1	8971S53KA
Double locking	Black	1	8971D53

Includes fixings.



Fencing Accessories



GATEMATE GRIPPLES (PACK OF 2)

DESCRIPTION	WIRE SIZE ins (mm)	FINISH	QTY/BOX	CODE
Small	1.40-2.20	Galvanised	5	543 0011
Medium	2.00-3.25	Galvanised	5	543 0021
Large	3.20-4.20	Galvanised	5	543 0041



GATEMATE RABBIT NETTING PEGS (PACK OF 5)

SIZE ins (mm)	FINISH	QTY/BOX	CODE
12 (300)	Galvanised	5	830 3001



GATEMATE ARRIS RAIL REPAIR BRACKETS (PACK OF 4)

DESCRIPTION	SIZE ins (mm)	FINISH	QTY/BOX	CODE
For 3" arris rail	12 (300)	Pre-Galvanised	5	831 0757
For 3" arris rail	13 (300)	Epoxy Brown	5	831 0759

Includes fixings.



GATEMATE PANEL FIXING CLIPS (PACK OF 4)

SIZE mm	FINISH	QTY/BOX	CODE
35x35	Pre-Galvanised	5	832 0357
45x50	Pre-Galvanised	5	832 0457
50x50	Pre-Galvanised	5	832 0507

Includes fixings.



GATEMATE BALUSTRADE BRACKETS (PACK OF 10)

SIZE mm	FINISH	QTY/BOX	CODE
40x40x30	Zinc Plated	5	832 0302

Includes fixings.



GATEMATE L BRACKET (PACK OF 10)

SIZE mm	FINISH	QTY/BOX	CODE
30x30x50	Pre-Galvanised	5	832 0287

Includes fixings.



GATEMATE SCREW IN PANEL CLIPS (PACK OF 4)

SIZE mm	FINISH	QTY/BOX	CODE
40x40x30	Galvanised	5	832 0401

A simple solution for securing fence panels to wooden fence posts.
Includes fixings.



GATEMATE CORNER BRACES

DESCRIPTION	SIZE ins (mm)	SCREW SIZE	FINISH	QTY/BOX	CODE
Pack of 10	1 (25)	6	Zinc Plated/YP	5	531 0258
Pack of 10	1½ (38)	6	Zinc Plated/YP	5	531 0388
Pack of 10	2 (50)	6	Zinc Plated/YP	5	531 0508
Pack of 5	2½ (65)	7	Zinc Plated/YP	5	531 0658
Pack of 5	3 (75)	7	Zinc Plated/YP	5	531 0758
Pack of 5	4 (100)	8	Zinc Plated/YP	5	531 1008
Pack of 5	6 (150)	10	Zinc Plated/YP	5	531 1508

Includes fixings.



GATEMATE CORNER PLATES

DESCRIPTION	SIZE ins (mm)	SCREW SIZE	FINISH	QTY/BOX	CODE
Pack of 10	2 (50)	7	Zinc Plated/YP	5	535 0508
Pack of 5	2½ (65)	7	Zinc Plated/YP	5	535 0658
Pack of 5	3 (75)	8	Zinc Plated/YP	5	535 0758
Pack of 5	4 (100)	8	Zinc Plated/YP	5	535 1008
Pack of 5	5 (125)	8	Zinc Plated/YP	5	535 1258
Pack of 5	6 (150)	8	Zinc Plated/YP	5	535 1508

Includes fixings.

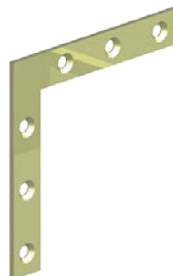

GATEMATE TEE PLATES

DESCRIPTION	SIZE ins (mm)	SCREW SIZE	FINISH	QTY/BOX	CODE
Pack of 5	3 (75)	8	Zinc Plated/YP	5	536 0758
Pack of 5	4 (100)	8	Zinc Plated/YP	5	536 1008

Includes fixings.



GATEMATE MENDING PLATES

DESCRIPTION	SIZE ins (mm)	SCREW SIZE	FINISH	QTY/BOX	CODE
Pack of 5	3 (75)	7	Zinc Plated/YP	5	537 0758
Pack of 5	4 (100)	7	Zinc Plated/YP	5	537 1008
Pack of 5	5 (125)	8	Zinc Plated/YP	5	537 1258
Pack of 5	6 (150)	8	Zinc Plated/YP	5	537 1508

Includes fixings.

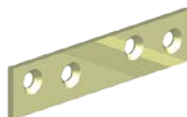

GATEMATE TABLE STRETCHER PLATES

DESCRIPTION	SIZE ins (mm)	SCREW SIZE	FINISH	QTY/BOX	CODE
Pack of 10	1½ (38)	8	Zinc Plated/YP	5	538 0388

Includes fixings.



Chain, Wire and Rope Fittings



GATEMATE PRE-CUT STRAIGHT LINK CHAIN ON HANGER CARDS

LENGTH	SIZE	FINISH	QTY/BOX	CODE
2m	3x21mm	Galvanised	5	578 0031
2m	4x26mm	Galvanised	5	578 0041
2m	5x28mm	Galvanised	5	578 0051
2m	6x42mm	Galvanised	5	578 0061

Size = thickness x inside of link.

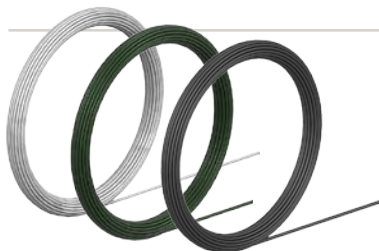

GATEMATE ½ KG COIL TYING WIRE

SIZE	FINISH	QTY/BOX	CODE
1.6mm	Galvanised	5	542 0011
2/1.4mm	Green PVC	5	542 0029
2/1.4mm	Black PVC	5	542 0039



GATEMATE ROPE ON WINDERS

DESCRIPTION	SIZE	FINISH	QTY/BOX	CODE
Multi function	8mm x 15m	White	5	579 1380
Polypropylene	8mm x 15m	Blue	5	579 1480
Polypropylene	8mm x 15m	Orange	5	579 1580
Multi function	4mm x 20m	White	5	579 2040
Polypropylene	6mm x 20m	Orange	5	579 2060
Polypropylene	6mm x 20m	Blue	5	579 2160
Multi function	6mm x 20m	White	5	579 2260



GATEMATE INTERMEDIATE FITTING FOR 4" POSTS (PACK OF 2)

SIZE ins (mm)	FINISH	QTY/BOX	CODE
¾ (10)	Galvanised	5	580 0101



GATEMATE END FITTING FOR 4" POSTS (PACK OF 2)

SIZE ins (mm)	FINISH	QTY/BOX	CODE
¾ (10)	Galvanised	5	581 0101



GATEMATE HOOKS ON PLATE (PACK OF 2)

SIZE ins (mm)	FINISH	QTY/BOX	CODE
2x2 (50x50)	Galvanised	5	582 0501

Includes fixings.



GATEMATE STAPLES ON PLATE (PACK OF 2)

SIZE ins (mm)	FINISH	QTY/BOX	CODE
2x2 (50x50)	Galvanised	5	583 0501

Includes fixings.



GATEMATE RING ON PLATE

SIZE ins (mm)	PLATE TYPE	FINISH	QTY/BOX	CODE
2x2 (50x50)	Standard	Galvanised	5	584 0501
4x2 (100x50)	Heavy Duty	Galvanised	5	546 1501

Includes fixings.



Standard Plate



Heavy Duty Plate

GATEMATE BUCKET CLIP ON PLATE

SIZE ins (mm)	FINISH	QTY/BOX	CODE
2x2 (50x50)	Galvanised	5	584 0001

Includes fixings.



GATEMATE MANGER RING ON EYEBOLT

SIZE ins (mm)	FINISH	QTY/BOX	CODE
3x8 (75x200)	Zinc Plated	5	585 0752

Includes fixings.



GATEMATE SPRING HOOKS TO CRUE (PACK OF 2)

SIZE ins (mm)	FINISH	QTY/BOX	CODE
2 (50)	Zinc Plated	5	586 0502
3 (75)	Zinc Plated	5	586 0752
3½ (88)	Zinc Plated	5	586 0882
4 (100)	Zinc Plated	5	586 1002



GATEMATE CARBINE HOOKS (PACK OF 2)

SIZE mm	FINISH	QTY/BOX	CODE
50x5	Zinc Plated	5	587 5052
60x6	Zinc Plated	5	587 6062
70x7	Zinc Plated	5	587 7072
80x8	Zinc Plated	5	587 8082
100x10	Zinc Plated	5	587 1002
120x11	Zinc Plated	5	587 1212



Chain, Wire and Rope Fittings

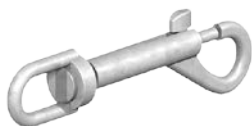

GATEMATE SWIVEL HARNESS SNAP HOOK

SIZE ins (mm)	FINISH	QTY/BOX	CODE
3x¾ (76x19)	Nickle Plated	5	588 0760



GATEMATE SWIVEL SPRING HOOKS

DESCRIPTION	SIZE ins (mm)	FINISH	QTY/BOX	CODE
Pack of 2	2 (50)	Zinc Plated	5	589 0502
Pack of 2	3 (75)	Zinc Plated	5	589 0752
Pack of 1	4 (100)	Zinc Plated	5	589 1002



GATEMATE BARREL STRAINERS (PACK OF 2)

SIZE ins (mm)	FINISH	QTY/BOX	CODE
¼ (6)	Zinc Plated	5	590 0062
⅜ (8)	Zinc Plated	5	590 0082
⅝ (10)	Zinc Plated	5	590 0102
½ (12)	Zinc Plated	5	590 0122



GATEMATE QUICK REPAIR LINKS

DESCRIPTION	DIAMETER mm	FINISH	QTY/BOX	CODE
Pack of 2	3	Zinc Plated	5	591 0032
Pack of 2	4	Zinc Plated	5	591 0042
Pack of 2	5	Zinc Plated	5	591 0052
Pack of 2	6	Zinc Plated	5	591 0062
Pack of 1	7	Zinc Plated	5	591 0072
Pack of 1	8	Zinc Plated	5	591 0082
Pack of 1	10	Zinc Plated	5	591 0102



GATEMATE SCREW HOOK (PACK OF 2)

SIZE ins (mm)	FINISH	QTY/BOX	CODE
3 (75)	Zinc Plated	5	592 0752



GATEMATE WIRE ROPE GRIPS

DESCRIPTION	DIAMETER mm	FINISH	QTY/BOX	CODE
Pack of 4	3	Zinc Plated	5	593 0032
Pack of 4	5	Zinc Plated	5	593 0052
Pack of 4	6	Zinc Plated	5	593 0062
Pack of 2	8	Zinc Plated	5	593 0082
Pack of 2	10	Zinc Plated	5	593 0102
Pack of 2	12	Zinc Plated	5	593 0122
Pack of 2	16	Zinc Plated	5	593 0162



Chain, Wire and Rope Fittings

GATEMATE DEE SHACKLES

DESCRIPTION	DIAMETER mm	FINISH	QTY/BOX	CODE
Pack of 4	5	Zinc Plated	5	594 0052
Pack of 4	6	Zinc Plated	5	594 0062
Pack of 2	8	Zinc Plated	5	594 0082
Pack of 2	10	Zinc Plated	5	594 0102
Pack of 2	12	Zinc Plated	5	594 0122
Pack of 2	16	Zinc Plated	5	594 0162



Trailer Fittings

GATEMATE TAILBOARD HOOKS (PACK OF 4)

DESCRIPTION	SIZE ins (mm)	FINISH	QTY/BOX	CODE
To bolt	5/16 (8)	Self Colour	5	835 0084
To bolt	3/8 (9.5)	Self Colour	5	835 0104



GATEMATE HINGE PINS (PACK OF 2)

DESCRIPTION	SIZE ins (mm)	FINISH	QTY/BOX	CODE
To bolt	1/2 (12)	Self Colour	5	836 0124
To bolt	5/8 (16)	Self Colour	5	836 0164
To weld	1/2 (12)	Self Colour	5	836 1124
To weld	5/8 (16)	Self Colour	5	836 1164



GATEMATE SHORT HINGE TO WELD (PACK OF 2)

SIZE ins (mm)	FINISH	QTY/BOX	CODE
6x1 1/2x1/2 (150x40x12)	Self Colour	5	837 0124
6x1 1/2x5/8 (150x40x16)	Self Colour	5	837 0164
6x1x1/2 (150x25x12)	Self Colour	5	837 1124

Size = Length x Width x Eye diameter.



GATEMATE SPADE HINGES TO WELD (PACK OF 2)

SIZE ins (mm)	FINISH	QTY/BOX	CODE
3x1 3/4x1/2 (75x44x12)	Self Colour	5	845 0124
3x1 3/4x5/8 (75x44x16)	Self Colour	5	845 0164

Size = Length x Width x Eye diameter.



Trailer Fittings



GATEMATE DROP CATCHES TO BOLT (PACK OF 2)

DESCRIPTION	SIZE ins (mm)	FINISH	QTY/BOX	CODE
Short	1 (25)	Zinc Plated	5	838 0252
Long	3 (75)	Zinc Plated	5	838 0752



GATEMATE COTTER PINS AND CHAIN (PACK OF 2)

SIZE ins (mm)	FINISH	QTY/BOX	CODE
1½ (38)	Zinc Plated	5	840 0382



GATEMATE RIVETTING PLUGS (PACK OF 2)

SIZE ins (mm)	FINISH	QTY/BOX	CODE
1¾x½ (46x12)	Self Colour	5	841 0464



GATEMATE LYNCH PINS (PACK OF 2)

DESCRIPTION	SIZE ins (mm)	FINISH	QTY/BOX	CODE
Small	¼ (6)	Zinc Plated	5	842 0062
Medium	5/16 (8)	Zinc Plated	5	842 0082
Large	7/16 (11)	Zinc Plated	5	842 0112



GATEMATE TOWING PIN

DIAMETER ins (mm)	FINISH	QTY/BOX	CODE
¾ (19)	Zinc Plated	5	843 0202
7/8 (22)	Zinc Plated	5	843 0222
1 (25)	Zinc Plated	5	843 0252



GATEMATE R CLIPS (PACK OF 4)

DESCRIPTION	SIZE ins (mm)	FINISH	QTY/BOX	CODE
Small	2½ (63x3)	Zinc Plated	5	844 0632
Large	4 (100x5)	Zinc Plated	5	844 1002

Metal Gates and Automation Accessories



GATEMATE ADJUSTABLE STEEL GATE POST SET

Robust 5mm hot dip galvanised steel construction with corrosion resistant epoxy black powder coating, giving a sleek, long-lasting finish. Includes post extension to concrete in, plastic covers, plastic base, pyramid cap and all fixings

SIZE mm	FINISH	QTY/PALLET	CODE
2440x150x150	Polyester black on galvanised	20	800 2443

PATENT PENDING.

Ideal for automated gate systems.

Robust 5mm hot-dip galvanised steel construction for wide, heavy gates.

Fully adjustable design!



NEW



GATEMATE STANDARD HINGE SET (PACK OF 2)

SIZE ins (mm)	PIN Ø mm	FINISH	QTY/BOX	CODE
12 (300)	19	Polyester black on galvanised	1	801 0193

PATENT PENDING.

Unique patented fixing method providing complete flexibility to place the hinge at any position. Includes all fixings.



NEW



GATEMATE ADJUSTABLE BOTTOM HINGE

DESCRIPTION	SIZE ins (mm)	FINISH	QTY/BOX	CODE
Left hand	16 (400)	Polyester black on galvanised	1	801 4033
Right hand	16 (400)	Polyester black on galvanised	1	801 4023

PATENT PENDING.

Fully adjustable heavy duty hinges for use with GateMate adjustable steel post. Includes all fixings.



NEW

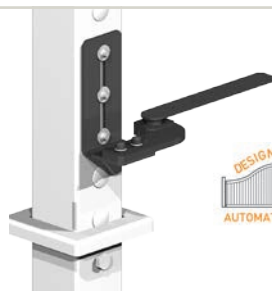

GATEMATE ADJUSTABLE TOP HINGE

DESCRIPTION	SIZE ins (mm)	FINISH	QTY/BOX	CODE
Left hand	16 (400)	Polyester black on galvanised	1	801 4013
Right hand	16 (400)	Polyester black on galvanised	1	801 4003

PATENT PENDING.

Fully adjustable heavy duty hinges for use with GateMate adjustable steel post. Includes all fixings.



NEW

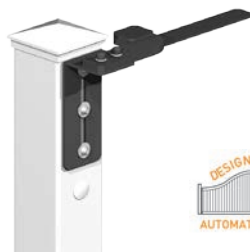

Metal Gates and Automation Accessories



WINDSOR BOW TOP METAL GATE

SIZE mm	SCREW SIZE mm	FINISH	QTY/BOX	CODE
1810*x740	820-920	Polyester black on galvanised	1	803 9003
1890*x815	900-1000	Polyester black on galvanised	1	803 1003

***Including ground clearance of 50mm.
Gates supplied with adjustable gate fixing kit.**



ASCOT SINGLE ENTRANCE GATE

SIZE mm	SCREW SIZE mm	FINISH	QTY/BOX	CODE
910*x740	820-920	Polyester black on galvanised	4	802 9003
910*x815	900-1000	Polyester black on galvanised	4	802 1003

***Including ground clearance of 50mm.
Gates supplied with adjustable gate fixing kit.**

METAL GATE POST

SIZE mm	FINISH	QTY/BOX	CODE
1300x50x50	Polyester black on BZP	1	800 1303
2400x50x50	Polyester black on BZP	1	800 2403

Post supplied with plastic end caps and self drilling screws for gate fixing kits.



GATEMATE METAL GATE FIXING KIT

FINISH	QTY/BOX	CODE
Epoxy black	5	599 0003

Gate kit includes: latch bar, 1 pair hinges, receiver plate and fixings to suit.



ADJUSTABLE METAL GATE FIXING KIT

FINISH	QTY/BOX	CODE
Epoxy black	5	801 0003

Gate kit includes: 2 x adjustable gate eyes, 2 x hinge mounts, padlockable latch assembly (padlock not included), receiving plate and fixings to suit.



Index

- A**
- Adjustable Bands and Hooks on Plates 24
 - Adjustable Gate Eye 17
 - Adjustable Gate Post Set 55
 - Adjustable Hinges for Automated Gates 55
 - Adjustable Metal Gate Fixing Kit 56
 - Aluminium Self Closing Hinges 47
 - Animal Safety Self Locking Gate Catch Kit 16
 - Armoured Block Padlock 11
 - Arris Rail Repair Brackets 48
 - Ascot Single Entrance Gate 56
 - Auto Gate Catch 30-31
 - Autolock Animal Bolt 28
- B**
- Balustrade Brackets 48
 - Band and Hook Hinges 23-24
 - Bands and Hooks on Plates-Adjustable 24
 - Barrel Strainers 52
 - Bottom Hinge-Adjustable 55
 - Bow Handle Bolt 29
 - Braced Adjustable Bands and Hooks on Plates 24
 - Brass Padlock 10
 - Brenton Padbolts 26-27
 - Bucket Clip on Plate 51
 - Butt Hinges 25
 - Butt Hinges - Stainless Steel 25
 - Butterfly Hinges - Ornamental 40
- C**
- Cabin Hooks 33, 39, 41
 - Cane Bolt 29
 - Carbine Hooks 51
 - Casement Stay 41
 - Cast Ball Knob Furniture-Ornamental 42
 - Cast Octagonal Door Furniture-Ornamental 42
 - Central Closing Catch 17
 - Chain Bolt 28
 - Chain End Fitting for 4" Posts 50
 - Child Safety Latch 46
 - Corner Braces 49
 - Corner Plates 49
 - Cotter Pins and Chain 54
 - Cranked Bands and Hooks on Plates 23, 36, 38
 - Cross Pattern Door Bolt 27
 - Curve Rail Hinge Kits Handed 19
- D**
- Dee Shackles 53
 - Discuss Padlock-Stainless Steel 11
 - Door Handles 42-43
 - Door Knob 42-43
 - Door Knocker 42
 - Door Pull 41
 - Door Studs 41
 - Door-Gate Handle 6-8, 41
 - Door-Gate Stop 33
 - Double Gate Fastener Set 16
 - Double Locking Gravity Latch 46
 - Double Strap Hinge Set 14-15
 - Drop Bolt 30, 36, 39
 - Drop Catches to Bolt 54
- E**
- Easy Close Auto Catch 31
 - Escutcheon Plate 7, 42
 - Euro Profile Long Throw Lock 5-6
- F**
- Field Gate Hinge Set 12-15
 - Fleur de Leys Door Handle 41
 - Fleur de Leys Hinges 40
 - Fleur de Leys Letter Plate 43
 - Fleur de Leys Lever Lock Handle 41
 - Folding Shelf Bracket 12
 - Foot Bolt 29
- G**
- Garage Door Bolt 30, 36, 39
 - Gate Catch 16, 30-31
 - Gate Eye-Adjustable 17
 - Gate Fastener Set 15-16

Index

- Gate Fixing Kit 56
- Gate Post 55-56
- Gate Return Spring 32
- Gate Signs 34
- Gate Staples 17-18
- Gate Wheel 18
- Gothic Suffolk Latch 31
- Gravity Latch 46
- Gripples 48
- H**
- Handrail Brackets 12
- Hasp and Staple 34-35
- High Visibility Reflectors 34
- Hinge Pins 53
- Hinge Set 12-15
- Hinge Set with Hooks on Plates 12-14
- Hinges 20-25, 36, 38, 40
- Hook and Band Hinges 23-24, 36, 38
- Hooks on Plate 50
- Hunting Type Catch Kit 17
- I**
- Intermediate Fitting for 4" Posts 50
- K**
- Kenham Gate Catch 32
- Kick Over Stable Latch 33
- L**
- L Bracket 48
- Letter Plate 43
- Lever Lock Handle 40-41
- Linch Pins 54
- Lion Door Knocker 42
- Locking Bars to Swivel 35
- Locking Garage Door Bolt 30, 36
- Long Throw Locks 5-7
- Long Throw Lock Pull Handles 6-7
- M**
- Magnetic Gate Latch 46-47
- Magnetic Side Pull 46
- Manger Ring on Eye Bolt 51
- Manta Magnetic Latch 46-47
- Mending Plates 49
- Metal Gate Fixing Kit 56
- Metal Gate Post 55-56
- Monkey Tail Bolt $\frac{5}{8}$ " Square Shoot 29
- N**
- Narrow Pattern Kick Over Stable Latch 33
- Necked Tower Bolt 26
- Netting Pegs 48
- New Zealand Gate Fastener 15
- Northumberland Gate Fastener 15
- Numerals - Ornamental 42
- O**
- Octagonal Door Knob 42
- Off-Set Hinges 22, 44-45
- Off-Set Self Closing Hinges with Legs 45
- Ornamental Butterfly Hinges 40
- Ornamental Cast Ball Knob Furniture 42
- Ornamental Cast Octagonal Door Furniture 42
- Ornamental Escutcheon Plate 42
- Ornamental Numerals 42
- Oval Pad Bolt 27
- P**
- Padbolts 26-27, 37
- Padlock Eyes 8
- Padlock Protector 8
- Padlocks 10-11
- Panel Clips 48
- Panel Fixing Clips 48
- Pedestrian Gate Kit 19
- Plain Ring Handle Only 32
- Premium Long Throw Lock 6-7
- Pressed Steel Handle 8
- Prikka Strip 9
- Pull Handles - Long Throw Locks 6-7
- Q**
- Quick Repair Links 52

Index

R

R Clips	54
Rabbit Netting Pegs	48
Rail Brackets	18
Reflectors	34
Reversible Hinges	24, 38
Rim Sashlock and Furniture	8
Rim Locks, Long Throw	5-7
Ring Gate Latch	19, 31-32, 37, 39, 43
Ring Handle Only	32, 43
Ring on Plate	51
Rising Hinge Set with Rocker Plate	14
Rivetting Plugs	54
Rope on Winders	50

S

Safety Gate Hook and Eye	15
Safety Latch	46
Safety Pattern Hasp and Staple	34
Screw Hook	52
Screw in Panel Clips	48
Security Escutcheon for Long Throw Lock	6-7
Self Closing Hinges	14, 44-45
Self Locking Gate Catch Kit	16
Shed Security Bar	9
Shelf Bracket	12
Shoot Bolt	17
Short Hinge to Weld	53
Side Gate Kit with Ring Gate Latch	19
Side Gate Kit with Suffolk Latch	19
Slip Rail Bracket	18
Spade Drill for Long Throw Locks	7
Spade Hinges to Weld	53
Spring Fastener Set	15
Spring Hooks to Crue	51
Spring Loaded Animal Bolt	28
Spring Loaded Bolt	28
Spring Loaded Gate Wheel	18
Stainless Steel Ball Bearing Butt Hinges	25

Stainless Steel Discuss Padlock	11
Staples on Plate, Elongated	18
Steel Gate Post Set-Adjustable	55
Straight Bands and Hooks on Plates	23, 36
Straight Door Bolt	41
Strap Hinges	12-15
Suffolk Latch	19, 31, 37, 39
Swivel Harness Snap Hook	52
Swivel Spring Hooks	52

T

Table Stretcher Plates	49
Tailboard Hooks	53
Tee Hinges	20-22, 36, 38, 40
Tee Plates	49
Throwover Loop	15
Top Hinge-Adjustable	55
Tower Bolt	26
Towing Pin	54
Turn Buttons	32
Twisted Ring Gate Latch	31
Tying Wire - ½Kg Coil	50

U

Unequal Hinges	40
Unsprung Gate Hinges	44

V

Vertical Pattern Hasp and Staple	35
----------------------------------	----

W

Weighty Scotch Tee Hinges	22
Windsor Bow Top Metal Gate	56
Wire Pattern Hasp and Staple	35
Wire Rope Grips	52

Z

Zinc Alloy Gravity Latch	47
--------------------------	----

GATEMATE®

SUPERIOR GATE FURNITURE

Authorised Distributor



Printed in the UK using vegetable based inks.
Printed on FSC certified paper from well managed Forests using mix sources.